

# Transair: Advanced Pipe Systems

## Compressed Air, Vacuum, Inert Gas

Catalog 3515 USA | February 2019



ENGINEERING YOUR SUCCESS.



OTSEGO, MICHIGAN



TIJUANA, MEXICO



ALBION, INDIANA



LAKEVIEW, MICHIGAN



MESA, ARIZONA

## **⚠ WARNING – USER RESPONSIBILITY**

FAILURE OR IMPROPER SELECTION OR IMPROPER USE OF THE PRODUCTS DESCRIBED HEREIN OR RELATED ITEMS CAN CAUSE DEATH, PERSONAL INJURY AND PROPERTY DAMAGE.

This document and other information from Parker-Hannifin Corporation, its subsidiaries and authorized distributors provide product or system options for further investigation by users having technical expertise.

The user, through its own analysis and testing, is solely responsible for making the final selection of the system and components and assuring that all performance, endurance, maintenance, safety and warning requirements of the application are met. The user must analyze all aspects of the application, follow applicable industry standards, and follow the information concerning the product in the current product catalog and in any other materials provided from Parker or its subsidiaries or authorized distributors.

To the extent that Parker or its subsidiaries or authorized distributors provide component or system options based upon data or specifications provided by the user, the user is responsible for determining that such data and specifications are suitable and sufficient for all applications and reasonably foreseeable uses of the components or systems.

## **Offer of Sale**

The items described in this document are hereby offered for sale by Parker Hannifin Corporation, its subsidiaries or its authorized distributors. This offer and its acceptance are governed by the provisions stated on the separate page of this document entitled "Offer of Sale".

## **Safe Drinking Water Act**

In accordance with 42 USC § 300g-6, parts in this catalog are to be used exclusively for nonpotable services such as manufacturing, industrial processing, irrigation, outdoor watering, or any other uses where the water is not anticipated to be used for human consumption. The only exceptions are parts described explicitly as "low lead" or suitable for potable water.

© Copyright 2017, Parker Hannifin Corporation, All Rights Reserved



**Parker Hannifin Corporation**  
Fluid Connectors Group  
Otsego, Michigan

# Regulations and Certifications

Parker complies with the regulations and certifications listed below. We go beyond the requirements to ensure a safe, high-performing product.



**ISO 9001 version 2008**

Parker Hannifin's Fluid System Connectors manufacturing facilities are certified ISO 9001 version 2008 and operates a Quality Management System in order to ensure the level of quality and service that is expected by its customers.



**TÜV certification**

A product certified TÜV is a pledge of safety and quality. The Group TÜV thus certifies independent test results – in particular, the properties of the products and the standards whereby they were examined.



**ASME B31.1/B31.3 certification**

Transair® meets the requirement of ASME B31.1 and B31.3 - which stipulates "the minimum requirements for the design, materials, fabrication, erection, test and inspection of power and auxiliary piping systems for industrial institutional plants" as "non boiler external piping".



**Qualicoat certification**

Qualicoat certification is a guarantee of the quality of the coating applied to Transair® aluminum pipe.



**ISO 8573 certification**

ISO 8573 is the international standard related to the quality of compressed air. Conformance to the ISO 8573 standard illustrates our commitment to providing clean dry air and the highest quality engineered piping systems.



**10 Year Warranty\***

Parker Hannifin Corporation warrants its Transair® products to be free of defects in material and workmanship for a period of ten (10) years from the date of purchase of the products. \*Transair® Condition Monitoring technology guaranteed for one (1) year.



**Safety certifications**

All Transair® components are non-flammable with no propagation of flame. Connectors and valves conform to UL94HB standard. Fixing clips conform to UL94V-2 standard. Flexible hoses conform to ISO 8030 / EN 12115 norm. The pipe powder coat finish is classified MO.



**CE conformity**

Transair® connectors manufactured by Parker Hannifin should be considered as piping components, which are designed according to sound working practice and therefore conforms to European standard 97/23 CEE - §3.3 (equipment under pressure).

# Transair Overview

<b>Transair® System</b>	<b>A2</b>	<b>Transair® Stainless Steel Range</b>	<b>E2</b>
Rigid Aluminum Pipe .....	A4	Technical Specifications .....	E4
Stickers .....	A6	Stainless Steel Pipe.....	E10
Flexible Hose.....	A7	Pipe-to-Pipe and Stud Connectors.....	E11
Pipe-to-Pipe and Threaded Connectors.....	A8	Drop Brackets .....	E16
Drop Brackets .....	A19	Quick Assembly Brackets and Wall Brackets.....	E17
Pressurized System Outlets .....	A22	Ball Valves and Butterfly Valves .....	E18
Valves .....	A25	Tools .....	E19
		The Golden Rules of Installation .....	E22
<b>Transair® Tools</b>	<b>B2</b>	<b>Numerical Index</b>	<b>F2</b>
Transair® Tools.....	B4		
<b>Transair® Accessories</b>	<b>C2</b>	<b>Parker Safety Guide</b>	<b>F10</b>
Transair® Fixture Accessories.....	C4		
Hose Reels.....	C6	<b>Offer of Sale</b>	<b>F13</b>
Composite Automatic Safety Couplers.....	C7		
<b>Transair® Installation Guide</b>	<b>D2</b>		
Essential Instructions.....	D4		
Aluminum Pipe Section.....	D7		
Pipe to Pipe Connectors.....	D11		
Quick Assembly Brackets.....	D21		
Transair® Flexible Hose .....	D27		
Fixture Accessories .....	D32		
Transair® systems in use .....	D43		

# TRANSAIR®

Compressed Air, Inert Gas and Vacuum

## Complete System



# Transair®

Transair® - the fast, flexible and easy to modify aluminum pipe system for compressed air, vacuum and inert gas applications. Transair® components are reusable and interchangeable, which enables immediate and easy layout modifications. Unlike the performance of steel or copper, which degrades over time due to corrosion, Transair® provides clean air quality with optimum flow rate performance.



## Transair® Conditioning Monitoring

Transair® Conditioning Monitoring - The state-of-the-art wireless condition monitoring solution that enables you to view the performance of your compressed air system 24 hours a day through a web based dashboard.

Transair® Conditioning Monitoring utilizes sophisticated wireless sensor technology to monitor their compressed air system and alert the end user of system changes by providing critical data that is gathered, compared and analyzed. Customized alerts fore warn facility personnel of any compressed air performance changes which helps to reduce downtime and increase productivity.



## Reduces Plant Energy Cost

As a direct result of increasing efficiency, reducing pressure drops and eliminating leaks.

## Commitment to Sustainability

Transair® pipe and fittings are 100% recyclable resulting in a decreased carbon introduction footprint.

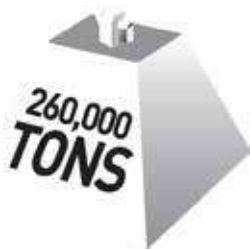

## Reduction of pipe installation weight by

# 260,000

tons for companies around the world. Over 20 years, this amounts to 88% reduction in Pipe Systems weight in our customers facilities.

## INSTALLATION ADVANTAGE

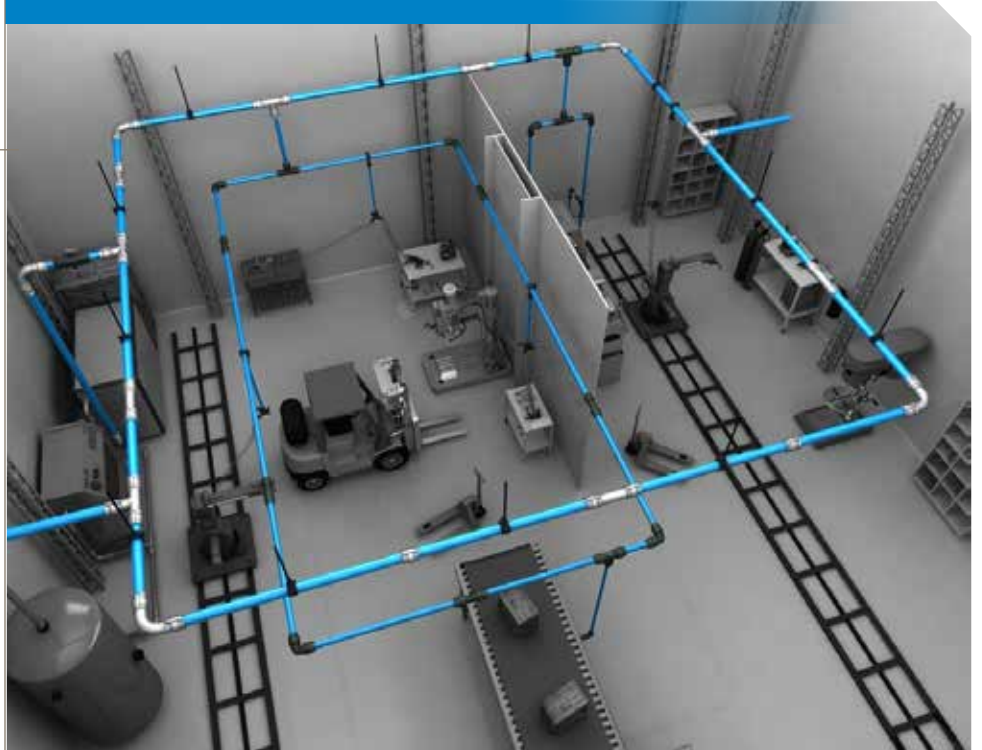

With Transair® our customers have decreased their use of pipe hangers by **20,000,000** hangers



## Resistance To Corrosion

Transair® is specifically powder-coated to enhance its mechanical, physical and chemical properties, making it ideal for aggressive industrial applications.

# WHAT IS EFFICIENCY?





# Compressed Air

## Industry Applications

- Automotive manufacturing
- Food and beverage
- Aerospace
- Energy
- Rail metal fabrication
- Paper and pulp
- Military
- Waste water treatment



# Inert Gas

## Industry Applications

- Microbulk gas delivery systems
- Plasma cutting applications
- Robotic installations
- Manual and automated welding operations



# Vacuum

## Industry Applications

- Composite materials
- Jewelry manufacturing
- Packaging





## AUTOMOTIVE

**Delivering quality compressed air for superior operational capacity.**



Transair® offers clean air quality and a full bore design which provides tool efficiency and an optimal machine for the automotive manufacturing industry. Transair's smooth calibrated aluminum construction offers a low friction coefficient with ideal laminar flow. The aluminum pipe also directly results in increased equipment longevity while avoiding frequent filtration media changes due to the clean air quality.

## APPLICATIONS

Powertrain | Paint & Finish | Trim & Interior | Casting | Assembly

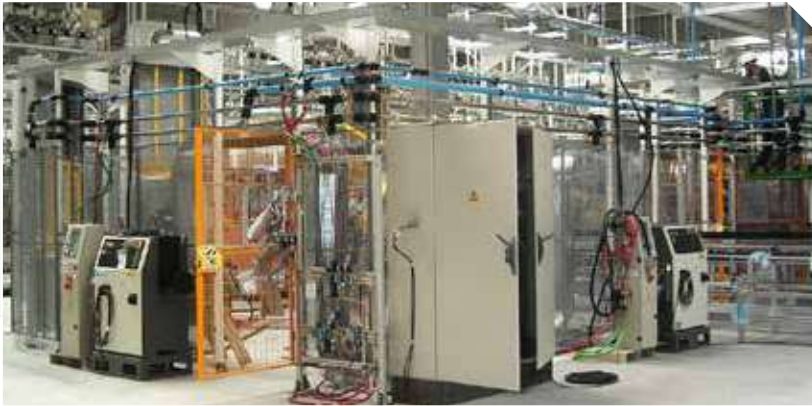

## PERFORMANCE EXPECTATIONS

- Quick connect
- Modular design
- No corrosion
- Energy efficient
- Immediate pressurization
- 10 year warranty
- 100% recyclable



## FAST, FLEXIBLE AND EASY TO MODIFY ALUMINUM PIPE SYSTEM

With Transair®, labor accounts for only 20 percent of installation costs



**Situation:** A major automotive manufacturer needed 6,500 ft of compressed air pipework for their car assembly plant. The compressed air system had to be installed over working production lines. Modularity was a major requirement to meet future needs.

**Solution:** In order to supply the Weld and Assembly Frame areas 1-1/2 inch Transair® drops were used from the steel pipe creating sub ring mains directly over

the production areas. In addition to nearly 6,560 ft of Transair's push-to-connect pipe the project required over 300 compressed air outlets and 80 plus ball valves. Transair® provided a compressed air system that carries and filters quality clear air to each point while incorporating pressure reducers.

**Benefits:** Fast, low-cost modular system for the compressed air system that allows for easy modification.





## FOOD AND BEVERAGE

**Improving production machine maintenance by delivering clean, dry compressed air.**



Compressed air is an essential component within the food and beverage manufacturing industry. The compressed air throughout food processing facilities must be free of contaminants in order to ensure the protection of consumable goods. The BCAS has developed a Code of Practice for Food Grade Compressed Air that defines a minimum acceptable purity (quality) for compressed air used in the food industry to assist food manufacturers.

# FOOD AND BEVERAGE

## APPLICATIONS

Handling | Conveying | Packaging | Filling | Washing | Labeling | Cooling

## PERFORMANCE EXPECTATIONS

- Quick connection technology
- No corrosion
- Optimum flow rate
- Expansion/contraction allowed
- Lower installation costs
- Provides dry clean air consistently



## CLEAN AND ROBUST

**Manufactured with a protective coating for longer life**



**Situation:** A global leader in the beverage industry chose Transair® for their 1,000ft compressed air configuration within the packaging and handling area throughout the bottling plant. The benefit of clean air, low production downtime and quick/easy modification capability contributed to the decision to install Transair®! The ease of modification was extremely beneficial for their filling and packaging stations that utilized compressed air.

**Benefits:** Fast, flexible and easy to modify piping. Clean compressed air solution





**transair<sup>®</sup>**

# Did you know?



# 40,000,000

Tons of CO<sub>2</sub> has NOT been produced around the world because companies are installing Transair<sup>®</sup> instead of using traditional solutions

This is equivalent to eliminating CO<sub>2</sub> emissions from



# 11,514

**cars for one year**



**9,800,000**



Labor hours have been saved around the world by installing Transair®

**500,000**

GWh of compressor energy has been saved by using Transair®



This is equivalent to 714 Million Refrigerators working at the same time for one year

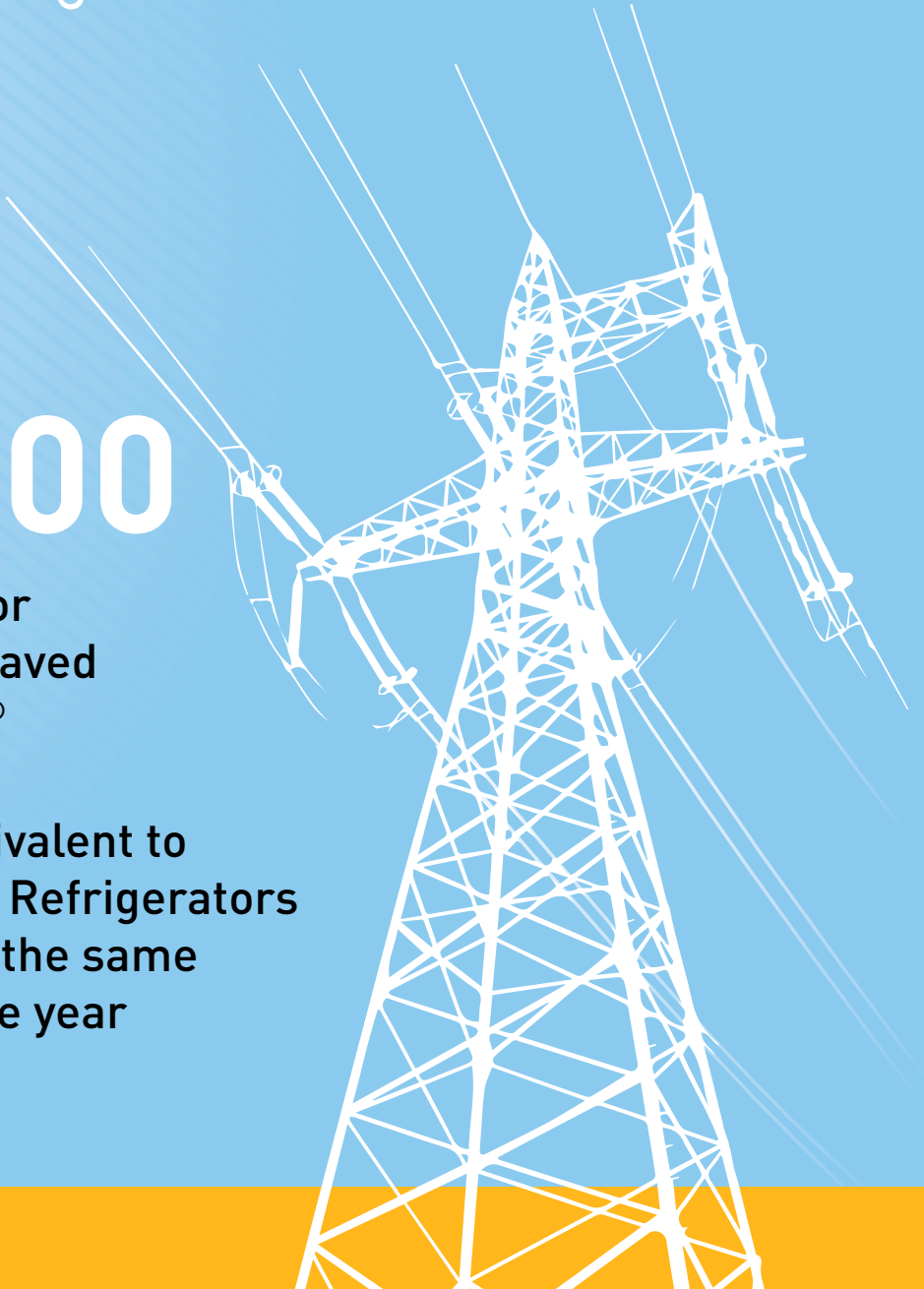

# Connection Technology

Transair's innovative technology enables rapid and easy assembly with quick connection of components to the aluminum pipe. This technology takes into account the specific requirements of each diameter and provides the user with an optimum safety coefficient and easy connection.

## 1/2" (16.5mm) • 1" (25mm) • 1-1/2" (40mm)

Pipe-to-pipe and male connectors in 1/2", 1" and 1 1/2" can be immediately connected to Transair® pipe – simply push the pipe into the connector up to the connection mark. The gripping ring of each fitting is then automatically secured and the connection is safe.

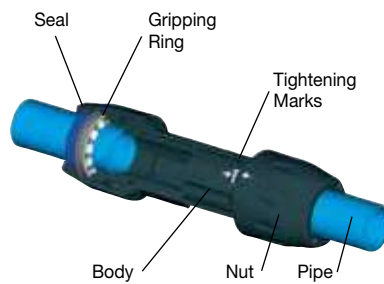

Installation Video

## 2" (50mm) • 2-1/2" (63mm)

Pipe-to-pipe and male connectors in 2" and 2 1/2" can be quickly connected to Transair® aluminum pipe by means of a snap ring. This secures the connection between the nut and the pipe – tightening of the nuts secures the final assembly.

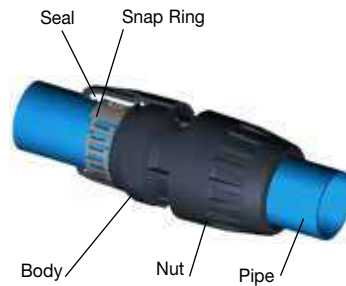

Installation Video

## 3" (76mm) • 4" (101mm) • 6" (168mm)

Pipe-to-pipe and male connectors in 3", 4" and 6" can be quickly connected to Transair® aluminum pipe. Position the pipes to be connected within a Transair® cartridge and close/tighten a Transair® clamp.

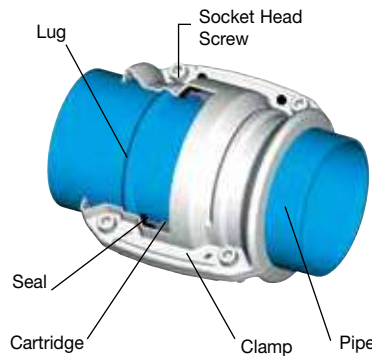

Installation Video



# Technical

## Suitable fluids

- compressed air (dry, wet, lubricated)
- vacuum
- inert gases
- Please consult us for other fluids

## Resistant to

- corrosion
- mineral compressor oils
- thermal variations
- aggressive environments
- synthetic compressor oils
- ultraviolet (UV)

- mechanical shocks
- compressor oil carry over

## Vacuum level

- 98.7% (29.6" Hg)

## Working Pressure and Temperature

The maximum working pressure of the Transair® system versus the operating temperature can be seen in the diagram below.

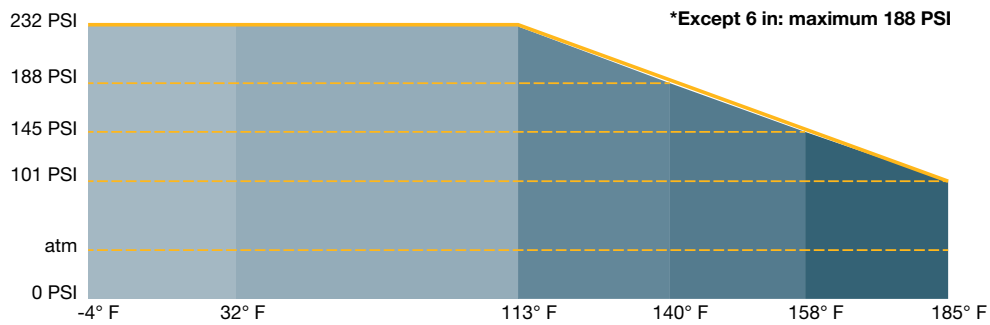

## Maximum Flow

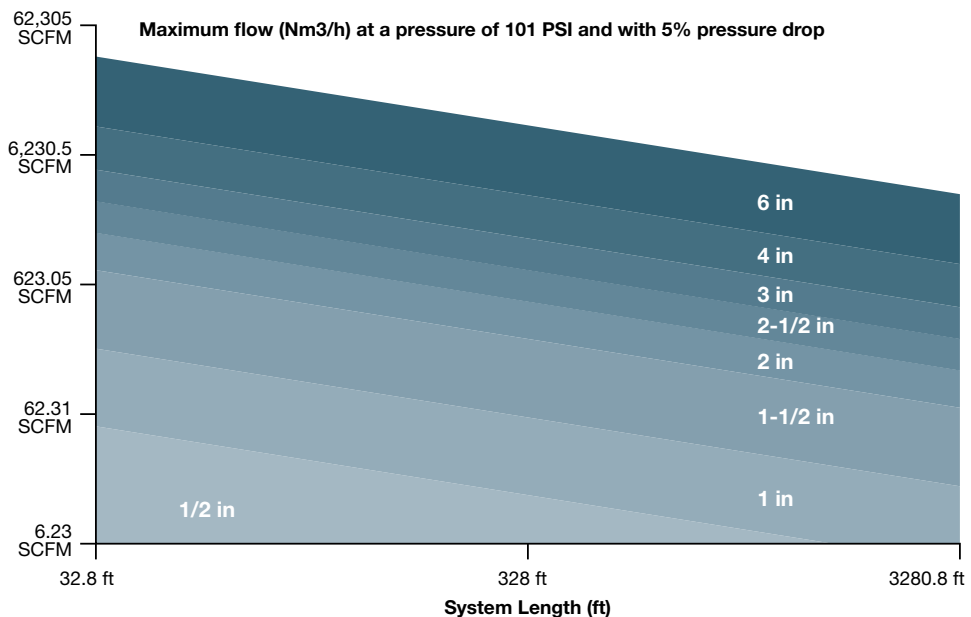

# Transair Materials Chart

PART NO.	OD 1/2 TO 1-1/2 (16,5MM TO 40MM)	OD 2 TO 2-1/2 (50MM TO 63MM)	OD 3 TO 6 (76MM TO 168MM)	CATALOG SECTION
1013A17	POWDER COATED ALUMINUM	-	-	RIGID ALUMINUM PIPE
1014A17	POWDER COATED ALUMINUM	-	-	RIGID ALUMINUM PIPE
1013A25	POWDER COATED ALUMINUM	-	-	RIGID ALUMINUM PIPE
1016A25	POWDER COATED ALUMINUM	-	-	RIGID ALUMINUM PIPE
1013A40	POWDER COATED ALUMINUM	-	-	RIGID ALUMINUM PIPE
1016A40	POWDER COATED ALUMINUM	-	-	RIGID ALUMINUM PIPE
1013A50	-	POWDER COATED ALUMINUM	-	RIGID ALUMINUM PIPE
1016A50	-	POWDER COATED ALUMINUM	-	RIGID ALUMINUM PIPE
1016A63	-	POWDER COATED ALUMINUM	-	RIGID ALUMINUM PIPE
1013A63	-	POWDER COATED ALUMINUM	-	RIGID ALUMINUM PIPE
TA16	-	-	POWDER COATED ALUMINUM	RIGID ALUMINUM PIPE
101E25	HOSE & COATING: BLACK SBR / NBR REINFORCEMENT: SPIRAL STEEL WIRE	-	-	FLEXIBLE HOSE
101E40	HOSE & COATING: BLACK SBR / NBR REINFORCEMENT: SPIRAL STEEL WIRE	-	-	FLEXIBLE HOSE
101E50	-	HOSE & COATING: BLACK SBR / NBR REINFORCEMENT: SPIRAL STEEL WIRE	-	FLEXIBLE HOSE
101E63	-	HOSE & COATING: BLACK SBR / NBR REINFORCEMENT: SPIRAL STEEL WIRE	-	FLEXIBLE HOSE
FP01	-	-	HOSE & COATING: BLACK SBR / NBR REINFORCEMENT: SPIRAL STEEL WIRE	FLEXIBLE HOSE
6606	POLYAMIDE WITH FIBERGLASS	TREATED ALUMINUM	-	PIPE-TO-PIPE AND THREADED CONNECTORS
6676	POLYAMIDE WITH FIBERGLASS	TREATED ALUMINUM	-	PIPE-TO-PIPE AND THREADED CONNECTORS
6650	-	FIBERGLASS	-	PIPE-TO-PIPE AND THREADED CONNECTORS
RR01	-	-	CLAMP: TREATED STEEL CARTRIDGE: POLYAMIDE WITH FIBERGLASS SEAL: NBR	PIPE-TO-PIPE AND THREADED CONNECTORS
RP00	-	-	POLYAMIDE WITH FIBERGLASS	PIPE-TO-PIPE AND THREADED CONNECTORS
EW04	-	-	STAINLESS STEEL 301	PIPE-TO-PIPE AND THREADED CONNECTORS
6602	POLYAMIDE WITH FIBERGLASS	TREATED ALUMINUM	-	PIPE-TO-PIPE AND THREADED CONNECTORS
RX02	-	-	STAINLESS STEEL 304	PIPE-TO-PIPE AND THREADED CONNECTORS
RA02	-	-	CAST ALUMINUM	PIPE-TO-PIPE AND THREADED CONNECTORS
6609	BODY: TREATED BRASS NUT: POLYMER HR / NBR	BODY: TREATED BRASS NUT: POLYMER HR / NBR	-	PIPE-TO-PIPE AND THREADED CONNECTORS
6612	POLYAMIDE WITH FIBERGLASS	TREATED ALUMINUM	-	PIPE-TO-PIPE AND THREADED CONNECTORS
RX12	-	-	STAINLESS STEEL 304	PIPE-TO-PIPE AND THREADED CONNECTORS
RA12	-	-	CAST ALUMINUM	PIPE-TO-PIPE AND THREADED CONNECTORS
6619	BODY: TREATED BRASS NUT: POLYMER HR / NBR	BODY: TREATED BRASS NUT: POLYMER HR / NBR	-	PIPE-TO-PIPE AND THREADED CONNECTORS
6604	POLYAMIDE WITH FIBERGLASS	TREATED ALUMINUM	-	PIPE-TO-PIPE AND THREADED CONNECTORS
RX04	-	-	STAINLESS STEEL 304	PIPE-TO-PIPE AND THREADED CONNECTORS
RA04	-	-	CAST ALUMINUM	PIPE-TO-PIPE AND THREADED CONNECTORS
RX24	-	-	STAINLESS STEEL 304	PIPE-TO-PIPE AND THREADED CONNECTORS

PART NO.	OD 1/2 TO 1-1/2 (16,5MM TO 40MM)	OD 2 TO 2-1/2 (50MM TO 63MM)	OD 3 TO 6 (76MM TO 168MM)	CATALOG SECTION
RA04	-	-	CAST ALUMINUM	PIPE-TO-PIPE AND THREADED CONNECTORS
RA44	-	-	CAST ALUMINUM	PIPE-TO-PIPE AND THREADED CONNECTORS
RA07	-	-	CAST ALUMINUM	PIPE-TO-PIPE AND THREADED CONNECTORS
RA26	-	-	CAST ALUMINUM	PIPE-TO-PIPE AND THREADED CONNECTORS
RX20	-	-	STAINLESS STEEL 304	PIPE-TO-PIPE AND THREADED CONNECTORS
6666	BODY: TREATED BRASS NUT: POLYAMIDE WITH FIBERGLASS	BODY: TREATED BRASS NUT: POLYAMIDE WITH FIBERGLASS	-	PIPE-TO-PIPE AND THREADED CONNECTORS
RX64	-	-	STAINLESS STEEL 304	PIPE-TO-PIPE AND THREADED CONNECTORS
RX66	-	-	STAINLESS STEEL 304	PIPE-TO-PIPE AND THREADED CONNECTORS
RA66	-	-	CAST ALUMINUM	PIPE-TO-PIPE AND THREADED CONNECTORS
6625	POLYAMIDE WITH FIBERGLASS	POLYAMIDE WITH FIBERGLASS	-	PIPE-TO-PIPE AND THREADED CONNECTORS
RX25	-	-	STAINLESS STEEL 304	PIPE-TO-PIPE AND THREADED CONNECTORS
RA25	-	-	CAST ALUMINUM	PIPE-TO-PIPE AND THREADED CONNECTORS
6605	BODY: TREATED BRASS NUT: POLYMER HR / NBR	BODY: TREATED BRASS NUT: POLYMER HR / NBR	-	PIPE-TO-PIPE AND THREADED CONNECTORS
6615	BODY: TREATED BRASS NUT: POLYMER HR / NBR	BODY: TREATED BRASS NUT: POLYMER HR / NBR	-	PIPE-TO-PIPE AND THREADED CONNECTORS
6611	TREATED BRASS	TREATED BRASS	-	PIPE-TO-PIPE AND THREADED CONNECTORS
6621	TREATED BRASS	-	-	PIPE-TO-PIPE AND THREADED CONNECTORS
RR21	-	-	STAINLESS STEEL 304	PIPE-TO-PIPE AND THREADED CONNECTORS
6651	BODY: TREATED BRASS NUT: POLYAMIDE WITH FIBERGLASS	-	-	PIPE-TO-PIPE AND THREADED CONNECTORS
6653	BODY: TREATED BRASS NUT: POLYMER HR	-	-	PIPE-TO-PIPE AND THREADED CONNECTORS
RX30	-	-	STAINLESS STEEL 304	PIPE-TO-PIPE AND THREADED CONNECTORS
RX31	-	-	STAINLESS STEEL 304	PIPE-TO-PIPE AND THREADED CONNECTORS
RA31	-	-	CAST ALUMINUM	PIPE-TO-PIPE AND THREADED CONNECTORS
RA30	-	-	CAST ALUMINUM	PIPE-TO-PIPE AND THREADED CONNECTORS
RA33	-	-	CAST ALUMINUM	PIPE-TO-PIPE AND THREADED CONNECTORS
EW05	-	-	NBR	PIPE-TO-PIPE AND THREADED CONNECTORS
EW06	-	-	STAINLESS STEEL 304	PIPE-TO-PIPE AND THREADED CONNECTORS
RA69	POLYAMIDE WITH FIBERGLASS	POLYAMIDE WITH FIBERGLASS	-	DROP BRACKETS
RA68	POLYAMIDE WITH FIBERGLASS	POLYAMIDE WITH FIBERGLASS	-	DROP BRACKETS
RR63	-	-	BODY: TREATED IRON SEAL: NBR	DROP BRACKETS
6662	POLYAMIDE WITH FIBERGLASS	POLYAMIDE WITH FIBERGLASS	-	DROP BRACKETS
6663	BODY: POLYAMIDE WITH FIBERGLASS INSERT: BRASS	BODY: POLYAMIDE WITH FIBERGLASS INSERT: BRASS	-	DROP BRACKETS
6668	BODY: POLYAMIDE WITH FIBERGLASS INSERT: BRASS	BODY: POLYAMIDE WITH FIBERGLASS INSERT: BRASS	-	DROP BRACKETS

PART NO.	OD 1/2 TO 1-1/2 (16.5MM TO 40MM)	OD 2 TO 2-1/2 (50MM TO 63MM)	OD 3 TO 6 (76MM TO 168MM)	CATALOG SECTION
EA98	BODY: TREATED IRON BALL VALVE: PLATED BRASS	BODY: TREATED IRON BALL VALVE: PLATED BRASS	-	PRESSURIZED SYSTEM OUTLET
6640	BODY: TREATED BRASS NUT: POLYMER HR / NBR	-	-	WALL BRACKETS
6642	TREATED BRASS	-	-	WALL BRACKETS
6689	TREATED BRASS	-	-	WALL BRACKETS
6691	TREATED BRASS	-	-	WALL BRACKETS
6684	BODY: TREATED BRASS NUT: POLYAMIDE WITH FIBERGLASS	-	-	WALL BRACKETS
6688	TREATED BRASS	-	-	WALL BRACKETS
6696	BODY: TREATED BRASS NUT: POLYMER HR SEAL: NBR	-	-	WALL BRACKETS
6636	BODY: TREATED BRASS NUT: POLYMER HR / NBR	-	-	WALL BRACKETS
6679	BODY: TREATED BRASS NUT: POLYMER HR / NBR	-	-	WALL BRACKETS
6694	BODY: TREATED BRASS NUT: POLYMER HR SEAL: NBR	-	-	WALL BRACKETS
6638	BODY: TREATED BRASS NUT: POLYMER HR / NBR	-	-	WALL BRACKETS
4092	BODY: TREATED BRASS NUT: ENGINEERING GRADE PLASTIC	BODY: TREATED BRASS NUT: TREATED ALUMINUM	-	VALVES
VR01	-	-	BODY: IRON DISC & SHAFT: STAINLESS STEEL	VALVES
VR03	-	BODY: DUCTILE IRON SEAL: NITRILE RETAINING RING: STAINLESS STEEL STEM: STAINLESS SPRING: STEEL	BODY: DUCTILE IRON SEAL: NITRILE RETAINING RING: STAINLESS STEEL STEM: STAINLESS SPRING: STEEL	VALVES
EW08	-	STEEL	STEEL	VALVES
EW10	-	-	LOW CARBON STEEL W/ CLEAR ZINC FINISH (CR3)	VALVES
4230	ALUMINUM	-	-	VALVES
4299	PLASTIC	-	-	VALVES
6697	POLYAMIDE WITH FIBERGLASS	POLYAMIDE WITH FIBERGLASS	-	FIXTURE ACCESSORIES
ER01	-	-	ZINC STEEL & RUBBER	FIXTURE ACCESSORIES
EX01	-	-	STAINLESS STEEL	FIXTURE ACCESSORIES
6697	POLYAMIDE WITH FIBERGLASS	POLYAMIDE WITH FIBERGLASS	-	FIXTURE ACCESSORIES
0169	STEEL	STEEL	-	FIXTURE ACCESSORIES
CP05	BODY: POLYMER HR / ZAMAC SLEEVE: POLYMER HR SPRING & BEARING: STAINLESS STEEL SEAL: NITRILE PROBE: TREATED STEEL	-	-	COUPLER
CP15	BODY: POLYMER HR / ZAMAC SLEEVE: POLYMER HR SPRING & BEARING: STAINLESS STEEL SEAL: NITRILE PROBE: TREATED STEEL	-	-	COUPLER
CP21	BODY: POLYMER HR / ZAMAC SLEEVE: POLYMER HR SPRING & BEARING: STAINLESS STEEL SEAL: NITRILE PROBE: TREATED STEEL	-	-	COUPLER
9084	BRASS	-	-	COUPLER
9083	BRASS	-	-	COUPLER
9085	BRASS	-	-	COUPLER

### Sizing Chart

Select the Transair® diameter for your application based on required flow against pressure drop. Estimated values: Closed loop system at 100 PSI with 5% pressure drop.

**Example**

- Main system length (ring main): 1000 ft
- Compressor power: 40 hp
- Required flow rate: 150 SCFM
- Working pressure: 100 PSI

Result: The most suitable Transair® diameter is: 1-1/2".

Flow Rate SCFM	Main Ring Length (ft)						Compressor hp
	500	1000	2000	3000	4000	5000	
10	1/2"	1/2"	1/2"	1"	1"	1"	<15
25	1"	1"	1"	1"	1"	1"	
50	1"	1"	1 1/2"	1 1/2"	1 1/2"	1 1/2"	
75	1"	1 1/2"	1 1/2"	1 1/2"	1 1/2"	1 1/2"	15 to 40
100	1 1/2"	1 1/2"	1 1/2"	1 1/2"	1 1/2"	1 1/2"	
150	1 1/2"	1 1/2"	1 1/2"	2"	2"	2"	
250	1 1/2"	1 1/2"	2"	2"	2 1/2"	2 1/2"	41 to 125
350	2"	2"	2 1/2"	2 1/2"	2 1/2"	2 1/2"	
500	2 1/2"	2 1/2"	2 1/2"	3"	3"	3"	
750	2 1/2"	2 1/2"	3"	3"	4"	4"	126 to 250
1000	3"	3"	3"	4"	4"	4"	
1250	3"	3"	4"	4"	4"	4"	
1500	4"	4"	4"	4"	4"	4"	125 to 500
1750	4"	4"	4"	4"	4"	4"	
2000	4"	4"	4"	4"	4"	6"	
2250	4"	4"	4"	6"	6"	6"	501 to 1000
2500	6"	6"	6"	6"	6"	6"	
2750	6"	6"	6"	6"	6"	6"	
3000	6"	6"	6"	6"	6"	6"	
3250	6"	6"	6"	6"	6"	6"	
3500	6"	6"	6"	6"	6"	6"	
4000	6"	6"	6"	6"	6"	6"	1001 to 1400
4500	6"	6"	6"	6"	6"	6"	
5000	6"	6"	6"	6"	6"	6"	
5500	6"	6"	6"	6"	6"	6"	



# Services and Tools

## Online tools

### Transair® Flow Calculator

Defines the recommended diameter for your project, estimates your pressure drops and gives the maximum flow rate by diameter

### Transair® Energy Savings Calculator

Evaluates the energy cost of your system and return on investment of a Transair® solution

### Transair® Value Calculator

Illustrates the typical savings achieved by installing Transair® in place of traditional steel or copper pipe systems

### CAD Drawings

View or download Transair® CAD drawings in 2D or 3D online

### Transair® Condition Monitoring How-to Videos

Get the most out of your Transair® Condition Monitoring system through our library of tutorial videos

### Transair® Condition Monitoring Installation Guide

Learn how to install Transair® Condition Monitoring sensors through our library of installation videos and PDF installation guide

## Services

Transair's technical team is at your disposal to study and help design your air system. In particular, we can assist you with:

- Information on Transair® products and services
- Quotation and drawing services
- Guidance and training on how to assemble the system
- Advice on “best practices” in order to reduce your consumption of energy
- Ongoing assistance and follow-up
- On-site advisory presence at construction and installation locations

Our customer service representatives will coordinate a quick response for the following:

- Product availability
- Delivery time-phasing and modification
- Order processing and follow-up
- Technical information / specification sheets



**Transair® Website**  
[www.parker.com/transair](http://www.parker.com/transair)

# SERVICES AND TOOLS



## CAD Drawings Available

Transair® CAD drawings available for a variety of software systems. Visit [www.parker.com/transair](http://www.parker.com/transair) for more information.

## Marketing Tools

We have the marketing and sales tools you need including brochures, specification sheets, demo/sample kits and more. Please contact the division for ordering information.



## Videos

Scan the QR tag above to see Transair® and Transair Condition Monitoring videos!







# Advanced Compressed Air System Condition Monitoring

## Product Features:

Having accurate, timely readings on the performance of your compressed air piping system could mean the difference between scheduled maintenance costs and unexpected downtime and expenses.

Transair® Condition Monitoring helps you keep your system healthy and operating efficiently. Transair® Condition Monitoring consists of a wide range of sensors that provide consistent and accurate readings for pressure, temperature, humidity, power, and flow. The system collects data so you can take the necessary steps to optimize your compressed air equipment and your system's performance. The easy-to-use web-based interface also alerts the user to unexpected conditions that may damage components and equipment over time.

Transair® Condition Monitoring puts vital information and analytics in the palm of your hand to ensure your compressed air system is running at optimum levels. Let Transair® Condition Monitoring Technology MONITOR your Transair® compressed air piping system, ALERT you to system changes, and provide DATA that helps reduce downtime and increase productivity.

- For commonly used pressure range of 0 to 150 PSI
- Software allows user-defined measurements
- Offered in corrosion-resistant materials for challenging environments
- All sensors report battery voltage and signal strength

## Sensor Technical Information:

<b>Pressure Range:</b>	0 to 150 PSI (0 to 10.3 bar)
<b>Burst Pressure:</b>	4x
<b>Temperature Range:</b>	-4° to +158° F (-20° to +65.5° C)
<b>Body Material:</b>	Polycarbonate
<b>Body Seals:</b>	Nitrile
<b>Certifications:</b>	FCC, IC
<b>Battery:</b>	CR123A (Panasonic suggested brand)
<b>Ip Rating* (Ingress Protection):</b>	IP65
<b>Port:</b>	1/4" female NPTF
<b>Full Range Life Cycle:</b>	> 1 million cycles

\* Does not apply to power sensors



For information on how to install Transair Condition Monitoring Sensors, visit:

[solutions.parker.com/TCM\\_Instructions](https://solutions.parker.com/TCM_Instructions)





transair®

# Architecture Overview

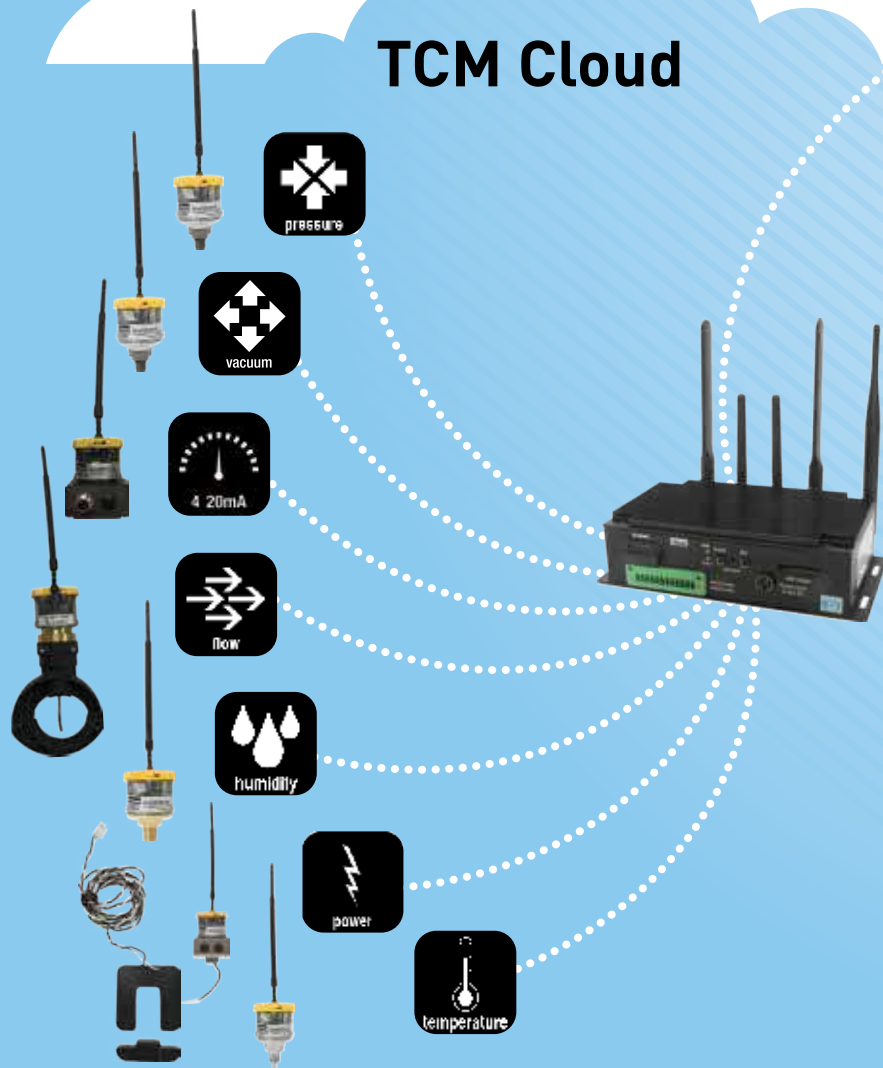

Take a new look at your compressed air system with Transair® Condition Monitoring. Transair Condition Monitoring provides you with the right data to make information-based decisions for managing your compressed air system.



Through the easy-to-use, web-based interface you have convenient access to your system status and analytics from any location at any time. Customizable alerts save valuable time by pushing the right information to you and your team via text or email. You can also discover new insights by viewing sensor measurements presented in trend charts that allow for historical trending and direct data download

Being confident & informed about your compressed air system empowers you to make intelligent system improvements that reduce your energy costs and increase your productivity and uptime.



# Transair<sup>®</sup> System

Rigid Aluminum Pipe

Flexible Hose

Pipe-to-Pipe and Threaded  
Connectors

Drop Brackets

Pressurized System Outlets

Wall Brackets

Valves





fountain pen nib  
DN50

F 43

8

# Rigid Aluminum Pipe

## Product Features:

- Clean air
- Optimum flow rate performance
- Lightweight
- QUALICOAT certified surface finish
- Three colors: blue (RAL 5012/BS1710), gray (RAL 7001), and green (RAL 6029) (other colors: please consult us)
- Suitable fluids: compressed air, vacuum, nitrogen, argon (other fluids: please consult us)
- Extruded pipe (conforms to EN 755.2, EN 755.8 and EN 573.3 standards)

## Specifications:

**Max. Working Pressure\*:** 188\*\* PSI from -4° to +140°F (12.9 bar from -20° to +60° C)

232 PSI from -4° to +115°F (15.9 bar from -20° to +46.1° C)

**Vacuum:** 98.7% (29.6" Hg)

**Working Temperature:** -4° to +140° F (-20° to +60° C)

\* Please consult page 15 for higher temperature requirements

\*\* 188 psi is the max for 6 inch (168mm) diameter pipe. 232 psi is the max for 1/2 inch - 4 inch.

### Blue Pipe



### Blue Pipe

PART NO.	OD (IN)	OD (MM)	NOMINAL LENGTH (FT)	WEIGHT (LB)
1013A17 04 00	1/2	16.5	9	1.41
1014A17 04	1/2	16.5	15	2.11
1013A25 04 00	1	25	9	2.12
1016A25 04 00	1	25	20	4.24
1013A40 04 00	1 1/2	40	9	3.11
1016A40 04 00	1 1/2	40	20	6.22



### Blue Pipe

PART NO.	OD (IN)	OD (MM)	NOMINAL LENGTH (FT)	WEIGHT (LB)
1013A50 04	2	50	9	4.80
1016A50 04	2	50	20	9.68
1013A63 04	2 1/2	63	9	6.92
1016A63 04	2 1/2	63	20	13.84



### Blue Pipe

PART NO.	OD (IN)	OD (MM)	NOMINAL LENGTH (FT)	WEIGHT (LB)
TA16 L1 04	3	76	20	16.98
TA16 L3 04	4	101	20	25.69
TA16 L8 04	6	168	20	64.84

**WARNING:** This product can expose you to chemicals including Titanium dioxide (airborne, unbound part) which is known to the State of California to cause cancer. For more information go to [www.P65Warnings.ca.gov](http://www.P65Warnings.ca.gov)



**Gray Pipe**



**Gray Pipe**

PART NO.	OD (IN)	OD (MM)	NOMINAL LENGTH (FT)	WEIGHT (LB)
1013A17 06 00	1/2	16.5	9	1.41
1016A25 06 00	1	25	20	4.24
1016A40 06 00	1 1/2	40	20	6.22

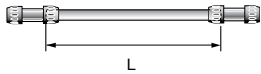

**Gray Pipe**

PART NO.	OD (IN)	OD (MM)	NOMINAL LENGTH (FT)	WEIGHT (LB)
1016A50 06	2	50	20	9.68
1016A63 06	2 1/2	63	20	13.84



**Gray Pipe**

PART NO.	OD (IN)	OD (MM)	NOMINAL LENGTH (FT)	WEIGHT (LB)
TA16 L1 06	3	76	20	16.98
TA16 L3 06	4	101	20	25.69
TA16 L8 06	6	168	20	64.84



**Green Pipe**

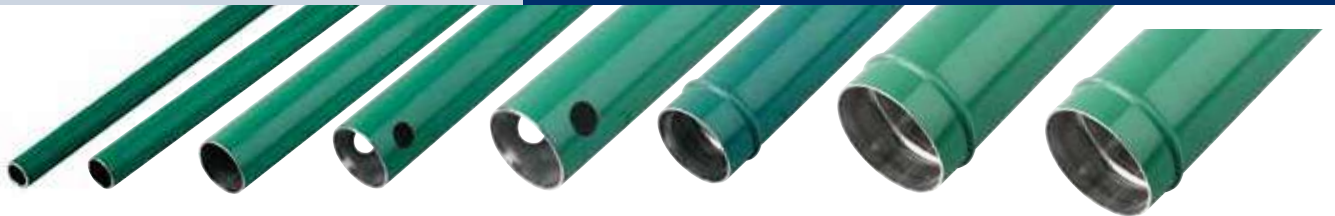

**Green Pipe**

PART NO.	OD (IN)	OD (MM)	NOMINAL LENGTH (FT)	WEIGHT (LB)
1014A17 02	1/2	16.5	15	2.11
1016A25 02 00	1	25	20	4.24
1016A40 02 00	1 1/2	40	20	6.22



**Green Pipe**

PART NO.	OD (IN)	OD (MM)	NOMINAL LENGTH (FT)	WEIGHT (LB)
1016A50 02	2	50	20	9.68
1016A63 02	2 1/2	63	20	13.84

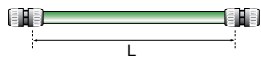

**Green Pipe**

PART NO.	OD (IN)	OD (MM)	NOMINAL LENGTH (FT)	WEIGHT (LB)
TA16 L1 02	3	76	20	16.98
TA16 L3 02	4	101	20	25.69
TA16 L8 02	6	168	20	64.84



**WARNING:** This product can expose you to chemicals including Titanium dioxide (airborne, unbound part) which is known to the State of California to cause cancer. For more information go to [www.P65Warnings.ca.gov](http://www.P65Warnings.ca.gov)



# Stickers



## Parker Transair® Logo Stickers

PART NO.	COLOR	QUANTITY	FOR USE WITH TRANSAIR® PIPE DIAMETER
TRN-L	BLACK WHITE	8 BLACK 8 WHITE	6
TRN-M	BLACK WHITE	8 BLACK 8 WHITE	3, 4
TRN-S	BLACK WHITE	8 BLACK 8 WHITE	2

## Flow Directional Arrow Stickers

PART NO.	COLOR	QUANTITY	FOR USE WITH TRANSAIR® PIPE DIAMETER
FL-ARROW-BLK-L*	BLACK	16	6
FL-ARROW-BLK-M*	BLACK	16	3, 4
FL-ARROW-BLK-S*	BLACK	16	2
FL-ARROW-WHT-L**	WHITE	16	6
FL-ARROW-WHT-M**	WHITE	16	3, 4
FL-ARROW-WHT-S**	WHITE	16	2

## Compressed Air Stickers

PART NO.	COLOR	QUANTITY	FOR USE WITH TRANSAIR® PIPE DIAMETER
CA-WHT-L**	WHITE	16	6
CA-WHT-M**	WHITE	16	3, 4
CA-WHT-S**	WHITE	16	2

## Vacuum Stickers

PART NO.	COLOR	QUANTITY	FOR USE WITH TRANSAIR® PIPE DIAMETER
VAC-BLK-L*	BLACK	16	6
VAC-BLK-M*	BLACK	16	3, 4
VAC-BLK-S*	BLACK	16	2

\* Includes 8 Black Parker Transair stickers

\*\* Includes 8 White Parker Transair stickers



# Flexible Hose

## Product Features:

- Compressor outlets (absorption of vibration)
- To bypass obstacles and join different levels
- Expansion loops
- Resistant to mineral and synthetic compressor oils
- Fire resistant (conforms to ISO 8030 standard for compressed air flexible hose and to EN 12.115 standard for vacuum flexible hose)

## Specifications:

**Max. Working Pressure\*:** 188 PSI from -4°F to +140°F (12.9 bar from -20° to +60° C)  
 232 PSI from -4°F to +115°F (15.9 bar from -20° to +46.1° C)

**Working Temperature:** -4° to +140° F (-20° to +60° C)

For installation information, see pages E27 through E31

### Diameters: 1" to 1-1/2" Flexible Hose for Compressed Air Systems

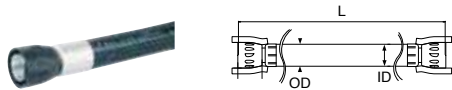

PART NO.	OD (IN)	OD (MM)	ID (IN)	ID (MM)	L (FT)	MIN. BEND RADIUS (IN)	FOR USE WITH TRANSAIR® PIPE DIAMETER
1001E25 00 01	1 1/2	38	1	25	1' 10"	4	1
1001E25 00 03	1 1/2	38	1	25	4' 11"	4	1
1001E25 00 04	1 1/2	38	1	25	6' 6"	4	1
1001E40 00 02	2 1/8	54	1 1/2	40	3' 9"	16	1 1/2
1001E40 00 04	2 1/8	54	1 1/2	40	6' 6"	16	1 1/2
1001E40 00 05	2 1/8	54	1 1/2	40	9' 10"	16	1 1/2

### Diameters: 2" to 2-1/2" Flexible Hose for Compressed Air Systems

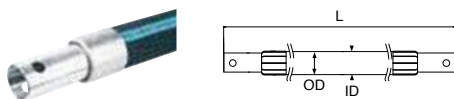

PART NO.	OD (IN)	OD (MM)	ID (IN)	ID (MM)	L (FT)	MIN. BEND RADIUS (IN)	FOR USE WITH TRANSAIR® PIPE DIAMETER
1001E50 00 09	2	63	2	50	3' 3"	11	2
1001E50 00 04	2	63	2	50	6' 6"	11	2
1001E63 00 08	3 1/8	79	2 1/2	63	4' 7"	12	2 1/2
1001E63 00 05	3 1/8	79	2 1/2	63	9' 10"	25	2 1/2
1001E63 00 06	3 1/8	79	2 1/2	63	13' 1"	25	2 1/2

### Diameters: 3" to 4" Flexible Hose for Compressed Air Systems

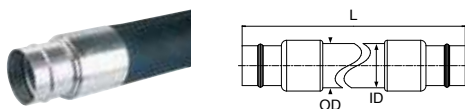

PART NO.	OD (IN)	OD (MM)	ID (IN)	ID (MM)	L (FT)	MIN. BEND RADIUS (IN)	FOR USE WITH TRANSAIR® PIPE DIAMETER
FP01 L1 01	3 4/7	91	3	76	4' 11"	14	3
FP01 L1 02	3 4/7	91	3	76	6' 6"	14	3
FP01 L3 02	4 1/2	116	4	101	6' 6"	20	4
FP01 L3 03	4 1/2	116	4	101	9' 10"	20	4

Use two connectors RR01 to connect flexible hoses FP01 to Transair® pipe.

### Anti Whip-Lash Strap



PART NO.	L (FT)	L (M)
6698 99 03	3' 3"	1

Prevents whip-lash should Transair® flexible hose be disconnected while under pressure.

**WARNING:** This product can expose you to chemicals including CARBON BLACK which is known to the State of California to cause cancer. For more information go to [www.P65Warnings.ca.gov](http://www.P65Warnings.ca.gov)

# Pipe-to-Pipe and Threaded Connectors

## Product Features:

- The range of Transair® pipe-to-pipe and stud connectors provides versatility of design and helps to overcome constraints often encountered with the structure of industrial buildings.
- Quick connection
- Full bore design, consistent inner diameter for both pipe and connectors.
- Reconfigurable and reusable

### Diameter: 1/2" to 1-1/2" Union Connector

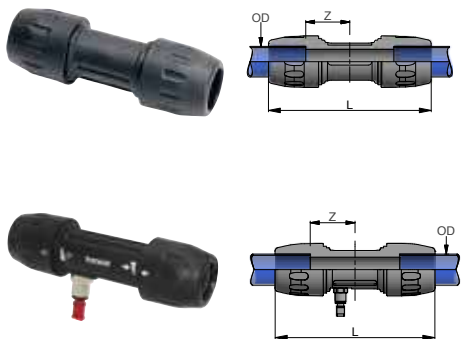

#### Standard

PART NO.	OD (IN)	OD (MM)	L (IN)	Z (IN)
6606 17 00	1/2	16.5	4.80	1.38
6606 25 00	1	25	6.08	1.89
6606 40 00	1 1/2	40	8.07	2.26

#### Vented

PART NO.	OD (IN)	OD (MM)	L (IN)	Z (IN)
6676 25 00	1	25	5.96	1.89
6676 40 00	1 1/2	40	8.07	2.26

Model supplied with G1/4" BSPP threaded fitting and Ø 8 mm push-in connection, complete with blanking plug.

### Diameter: 2" to 2-1/2" Union Connector

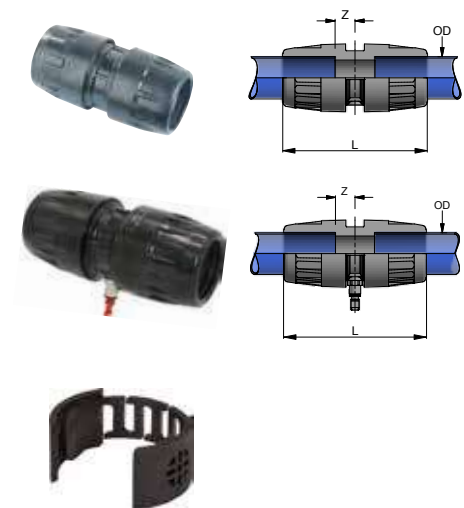

#### Standard

PART NO.	OD (IN)	OD (MM)	L (IN)	Z (IN)
6606 50 00	2	50	6.73	.98
6606 63 00	2 1/2	63	6.89	1.00

#### Vented

PART NO.	OD (IN)	OD (MM)	L (IN)	Z (IN)
6676 50 00	2	50	6.73	.98
6676 63 00	2 1/2	63	6.89	1.00

Model supplied with G1/4" BSPP threaded fitting and Ø 8 mm push-in connection, complete with blanking plug.

#### Replacement Snap Ring

PART NO.	OD (IN)	OD (MM)
6650 00 00 16	2	50
6650 00 00 04	2 1/2	63

**WARNING:** This product can expose you to chemicals including Lead and Lead Compounds which is known to the State of California to cause cancer and birth defects or other reproductive harm. For more information go to [www.P65Warnings.ca.gov](http://www.P65Warnings.ca.gov)

**Diameter: 3" to 6"**

**Union Clamp and Cartridge**



**Stainless Steel Clamp (Includes Cartridge)**

PART NO.	OD (IN)	OD (MM)	L (IN)
RR01 L1 00	3	76	5.75
RR01 L3 00	4	101	5.75



**Cast Aluminum Clamp (Includes Cartridge)**

PART NO.	OD (IN)	OD (MM)	L (IN)
RR01 L8 00	6	168	5.47



**Cartridge (Replacement Part)**

PART NO.	OD (IN)	OD (MM)
RP00 L1 00	3	76
RP00 L3 00	4	101
RP00 L8 00	6	168



**Bolts (Replacement Part)**

PART NO.	OD (IN)	OD (MM)	THD SIZE (MM)	L (IN)	HEX(MM)
EW04 00 01	3, 4	76, 101	M8 X 1.25	1.5	6

**Diameter: 1/2" to 1-1/2"**

**90° Elbow**

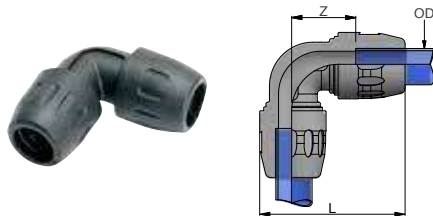

PART NO.	OD (IN)	OD (MM)	L (IN)	Z (IN)
6602 17 00	1/2	16.5	2.32	1.30
6602 25 00	1	25	2.74	1.59
6602 40 00	1 1/2	40	4.06	2.44

**Diameter: 2" to 2-1/2"**

**90° Elbow**

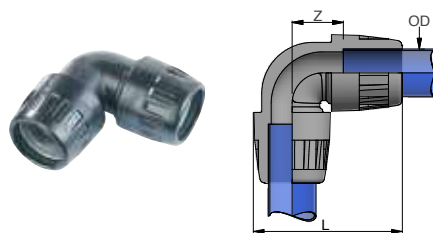

PART NO.	OD (IN)	OD (MM)	L (IN)	Z (IN)
6602 50 00	2	50	6.14	2.20
6602 63 00	2 1/2	63	6.69	2.46

**WARNING:** This product can expose you to chemicals including Lead and Lead Compounds which is known to the State of California to cause cancer and birth defects or other reproductive harm. For more information go to [www.P65Warnings.ca.gov](http://www.P65Warnings.ca.gov)

Diameter: 3" to 6"

90° Elbow

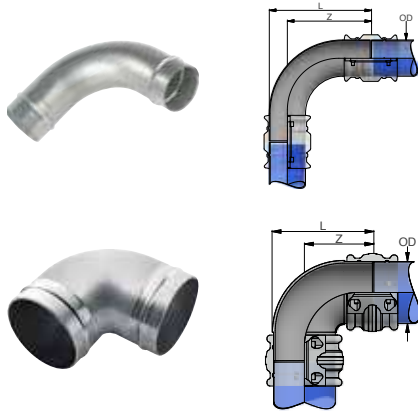

Stainless Steel

PART NO.	OD (IN)	OD (MM)	L (IN)	Z (IN)
RX02 L1 00	3	76	8.94	7.44
RX02 L3 00	4	101	10.94	8.94

Use two connectors (RR01) to connect 90° elbow (RX02) to Transair® pipe.

Cast Aluminum

PART NO.	OD (IN)	OD (MM)	L (IN)	Z (IN)
RA02 L8 00	6	168	10.59	7.28

Use two connectors (RR01) to connect 90° elbow (RA02) to Transair® pipe.

Diameter: 1/2" to 2-1/2"

Male Threaded NPT 90° Elbow

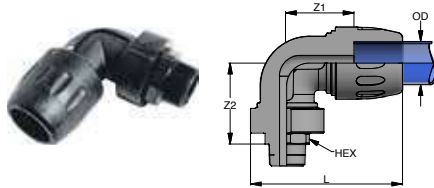

PART NO.	OD (IN)	OD (MM)	THD SIZE (IN)	HEX (MM)	L (IN)	Z1 (IN)	Z2 (IN)
6609 17 14	1/2	16.5	1/4	17	2.95	1.22	2.29
6609 17 22	1/2	16.5	1/2	23	2.95	1.22	2.50
6609 25 22	1	25	1/2	27	3.63	1.59	2.97
6609 25 28	1	25	3/4	27	3.63	1.59	2.97
6609 25 35	1	25	1	36	3.63	1.59	3.05
6609 40 35	1 1/2	40	1	41	5.40	2.44	4.13
6609 40 43	1 1/2	40	1 1/4	50	5.40	2.44	4.33
6609 40 50	1 1/2	40	1 1/2	50	5.40	2.44	4.33
6609 40 44	1 1/2	40	2	60	5.40	2.44	4.76
6609 50 50	2	50	1 1/2	50	6.14	2.20	5.39
6609 50 44	2	50	2	60	6.14	2.20	5.47
6609 63 41	2 1/2	63	2 1/2	80	6.71	2.48	5.94
6609 63 46	2 1/2	63	3	95	6.71	2.48	5.04

Diameter: 1" to 2-1/2"

45° Elbow

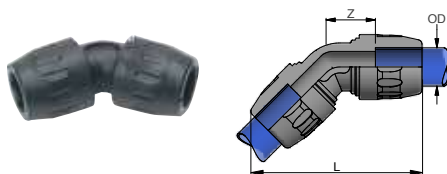

PART NO.	OD (IN)	OD (MM)	L (IN)	Z (IN)
6612 25 00	1	25	4.65	1.28
6612 40 00	1 1/2	40	6.77	1.77
6612 50 00	2	50	7.44	1.50
6612 63 00	2 1/2	63	7.76	1.50

**WARNING:** This product can expose you to chemicals including Lead and Lead Compounds which is known to the State of California to cause cancer and birth defects or other reproductive harm. For more information go to [www.P65Warnings.ca.gov](http://www.P65Warnings.ca.gov)

Diameter: 3" to 6"

45° Elbow

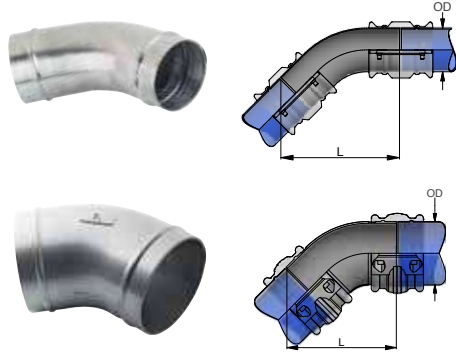

Stainless Steel

PART NO.	OD (IN)	OD (MM)	L (IN)
RX12 L1 00	3	76	9.27
RX12 L3 00	4	101	10.69

Use two connectors (RR01) to connect 45° elbow (RX12) to Transair® pipe.

Cast Aluminum

PART NO.	OD (IN)	OD (MM)	L (IN)
RA12 L8 00	6	168	11.57

Use two connectors (RR01) to connect 45° elbow (RA12) to Transair® pipe.

Diameter: 1" to 2-1/2"

Male Threaded NPT 45° Elbow

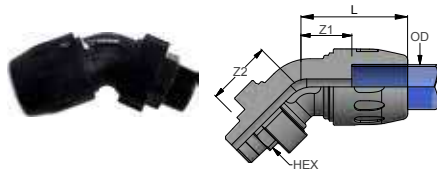

PART NO.	OD (IN)	OD (MM)	THD SIZE (IN)	HEX (IN)	L (IN)	Z1 (IN)	Z2 (IN)
6619 25 22	1	25	1/2	27	2.42	1.28	1.65
6619 25 28	1	25	3/4	27	2.42	1.28	1.65
6619 25 35	1	25	1	36	2.42	1.28	1.73
6619 40 35	1 1/2	40	1	41	3.70	1.77	2.30
6619 40 43	1 1/2	40	1 1/4	50	3.70	1.77	2.52
6619 40 50	1 1/2	40	1 1/2	50	3.70	1.77	2.52
6619 40 44	1 1/2	40	2	60	3.70	1.77	2.52
6619 50 50	2	50	1 1/2	50	3.86	1.50	3.15
6619 50 44	2	50	2	60	3.86	1.50	3.23
6619 63 44	2 1/2	63	2	70	3.94	1.50	3.19

Diameter: 1" to 2-1/2"

Equal Tee

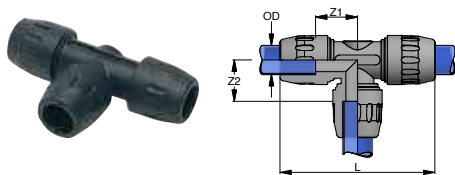

PART NO.	OD (IN)	OD (MM)	L (IN)	Z1 (IN)	Z2 (IN)
6604 17 00	1/2	16.5	4.80	1.40	1.30
6604 25 00	1	25	5.98	1.89	1.57
6604 40 00	1 1/2	40	8.07	2.26	2.26

Diameter: 2" to 2-1/2"

Equal Tee

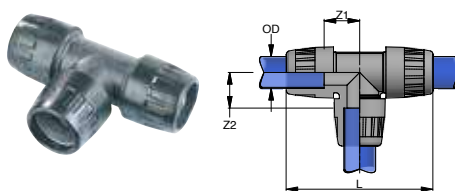

PART NO.	OD (IN)	OD (MM)	L (IN)	Z1 (IN)	Z2 (IN)
6604 50 00	2	50	9.09	2.20	2.20
6604 63 00	2 1/2	63	9.84	2.46	2.46

**WARNING:** This product can expose you to chemicals including Lead and Lead Compounds which is known to the State of California to cause cancer and birth defects or other reproductive harm. For more information go to [www.P65Warnings.ca.gov](http://www.P65Warnings.ca.gov)

Diameters: 3" to 6"

Equal Tee

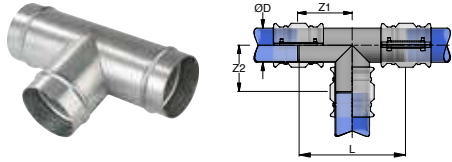

PART NO.	OD (IN)	OD (MM)	L (IN)	Z1 (IN)	Z2 (IN)
RX04 L1 00	3	76	11.50	5.75	5.75
RX04 L3 00	4	101	12.28	6.14	5.35
RA04 L8 00	6	168	14.17	7.09	7.28

Use three connectors (RR01) to connect equal tees (RX04 and RA04) to Transair® pipe.

Diameters: 2" to 2-1/2"

Reducing Tee

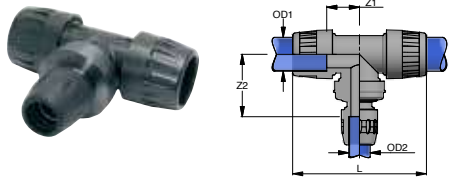

PART NO.	OD1 (IN)	OD1 (MM)	OD2 (IN)	OD2 (MM)	L (IN)	Z1 (IN)	Z2 (IN)
6604 50 25	2	50	1	25	9.09	2.20	4.37
6604 50 40	2	50	1 1/2	40	9.09	2.20	4.21
6604 63 40	2 1/2	63	1 1/2	40	9.84	2.46	4.76
6604 63 50	2 1/2	63	2	50	9.84	2.46	4.60

Diameters: 3" to 6"

Reducing Tee

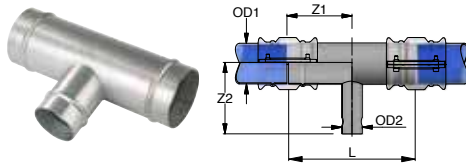

Stainless Steel

PART NO.	OD1 (IN)	OD1 (MM)	OD2 (IN)	OD2 (MM)	L (IN)	Z1 (IN)	Z2 (IN)
RX24 L1 40	3	76	1 1/2	40	11.50	5.75	4.13
RX24 L1 50	3	76	2	50	11.50	5.75	6.30
RX24 L1 63	3	76	2 1/2	63	11.50	5.75	6.46
RX24 L3 40	4	101	1 1/2	40	12.28	6.14	4.63
RX24 L3 50	4	101	2	50	12.28	6.14	6.81
RX24 L3 63	4	101	2 1/2	63	12.28	6.14	6.97
RX04 L3 L1	4	101	3	76	12.28	6.14	5.35

Use two connectors (RR01) to connect reducing tees (RX24) to Transair® Ø 3" and Ø 4" pipes and use one connector (6606) to connect Transair® Ø 1 1/2" and Ø 2 1/2" pipes.

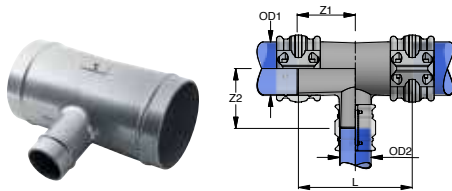

Cast Aluminum

PART NO.	OD1 (IN)	OD1 (MM)	OD2 (IN)	OD2 (MM)	L (IN)	Z1 (IN)	Z2 (IN)
RA04 L8 L3	6	168	4	101	14.17	7.09	7.28
RA04 L8 L1	6	168	3	76	14.17	7.09	7.28
RA04 L8 63	6	168	2 1/2	63	14.17	7.09	8.66

Use two connectors (RR01) to connect reducing tees (RA24) to Transair® Ø 6" pipes and use one connector (6606) to connect Transair® Ø 2 1/2" pipes.

Diameters: 3" to 6"

1 Flanged Tee

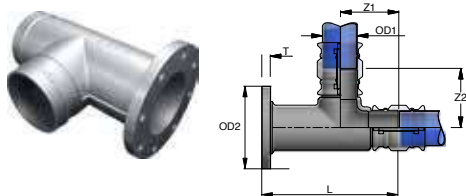

PART NO.	OD1 (IN)	OD1 (MM)	FLANGE SIZE (IN)	OD2 (IN)	T (IN)	L (IN)	Z1 (IN)	STANDARD
RA44 L1 00 46	3	76	3	7.48	.97	14.02	5.87	ANSI
RA44 L3 00 46	4	101	4	9.06	.97	14.96	6.34	ANSI
RA44 L8 00 46	6	168	6	11.02	1.03	17.67	7.52	ANSI

Use two connectors (RR01) to connect 1 flanged tees to Transair® pipe.

**WARNING:** This product can expose you to chemicals including Lead and Lead Compounds which is known to the State of California to cause cancer and birth defects or other reproductive harm. For more information go to [www.P65Warnings.ca.gov](http://www.P65Warnings.ca.gov)

Diameters: 3" to 6"

3 Flanged Cross

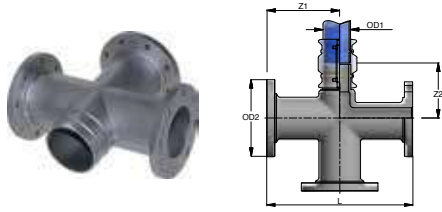

PART NO.	OD1 (IN)	OD1 (MM)	FLANGE SIZE (IN)	OD2 (IN)	T (IN)	L (IN)	Z1 (IN)	Z2 (IN)	STANDARD
RA07 L1 03 46	3	76	3	7.48	.97	16.30	8.15	5.87	ANSI
RA07 L3 03 46	4	101	4	9.06	.97	17.24	8.62	6.34	ANSI
RA07 L8 03 46	6	168	6	11.02	1.03	20.29	10.15	7.52	ANSI

Use one connector (RR01) to connect 3 flanged crosses to Transair® pipe.

Diameters: 2-1/2" to 4"

Expanding Tee

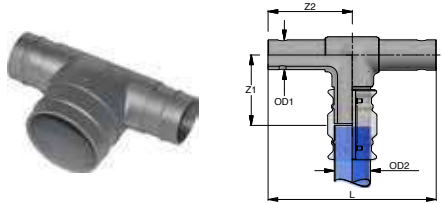

PART NO.	OD1 (IN)	OD1 (MM)	OD2 (IN)	OD2 (MM)	L (IN)	Z1 (IN)	Z2 (IN)
RA04 63 L1	2 1/2	63	3	76	13.70	5.59	6.85
RA04 L1 L3	3	76	4	101	12.68	5.87	6.34
RA04 L3 L8	4	101	6	168	15.28	6.34	7.64

Use two connectors (6606) and one connector (RR01) to connect expanding tee (RA04 63 L1) to Transair® Ø 2 1/2" and Ø 3" pipes.

Use 3 connectors (RR01) to connect expanding tees (RA04 L1 L3 and RA04 L3 L8) to Transair® Ø 3", Ø 4", and Ø 6" pipes.

Diameters: 2-1/2" to 6"

Equal Y

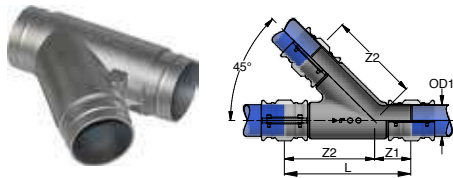

PART NO.	OD1 (IN)	OD1 (MM)	L (IN)	Z1 (IN)	Z2 (IN)
RA26 63 00	2 1/2	63	17.01	5.98	11.02
RA26 L1 00	3	76	13.50	4.17	9.33
RA26 L3 00	4	101	15.59	4.57	11.02
RA26 L8 00	6	168	18.74	4.96	13.78

Use three connectors (6606) to connect equal Y (RA26 63 00) to Transair® Ø 2 1/2" pipe.

Use 3 connectors (RR01) to connect equal Y (RA26 L1 00, RA26 L3, 00, and RA26 L8 00) to Transair® 3", 4", and 6" pipes.

Diameters: 3" to 6"

Reducing Y

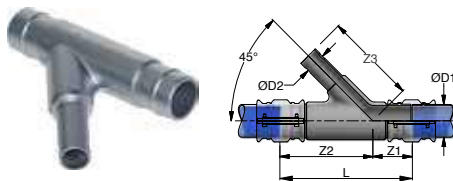

PART NO.	OD1 (IN)	OD1 (MM)	OD2 (IN)	OD2 (MM)	L (IN)	Z1 (IN)	Z2 (IN)	Z3 (IN)
RA26 L1 40	3	76	1 1/2	40	14.41	4.17	10.24	9.06
RA26 L1 50	3	76	2	50	14.41	4.17	10.24	11.02
RA26 L1 63	3	76	2 1/2	63	14.41	4.17	10.24	11.02
RA26 L3 63	4	101	2 1/2	63	15.59	4.57	11.02	11.02
RA26 L3 L1	4	101	3	76	15.59	4.57	11.02	11.02
RA26 L8 L3	6	168	4	101	15.44	3.39	12.05	12.99

Use two connectors (RR01) and one connector (6606) to connect reducing Y (RA26 L1 40, RA26 L1 50, RA26 L1 63, and RA26 L3 63) to Transair® Ø 1 1/2", Ø 2", and Ø 2 1/2" pipes.

Use three connectors (RR01) to connect reducing Y (RA26 L3 L1 and RA26 L8 L3) to Transair® Ø 3", Ø 4", and Ø 6" pipes.

Diameter: 3" to 4"

Female Threaded NPT Tee

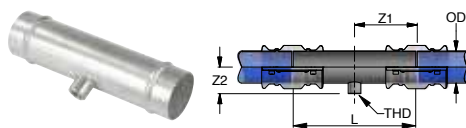

PART NO.	OD (IN)	OD (MM)	L (IN)	Z1 (IN)	Z2 (IN)	THD SIZE (IN)
RX20 L1N04	3	76	11.50	5.75	2.48	1/2
RX20 L3N04	4	101	12.28	6.14	2.98	1/2

Use two connectors (RR01) to connect threaded tees (RX20) to Transair® pipe.

**WARNING:** This product can expose you to chemicals including Lead and Lead Compounds which is known to the State of California to cause cancer and birth defects or other reproductive harm. For more information go to [www.P65Warnings.ca.gov](http://www.P65Warnings.ca.gov)

**Diameter: 1-1/2" to 6"**

**Equal Cross**

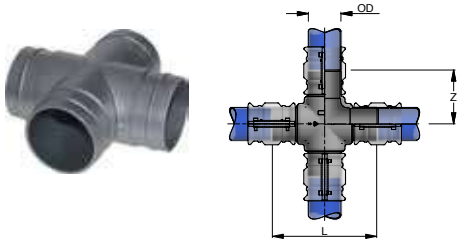

PART NO.	OD (IN)	OD (MM)	L (IN)	Z (IN)
RA07 40 00	1 1/2	40	9.92	4.96
RA07 50 00	2	50	14.02	7.01
RA07 63 00	2 1/2	63	14.33	7.17
RA07 L1 00	3	76	11.73	5.87
RA07 L3 00	4	101	12.68	6.34
RA07 L8 00	6	168	15.04	7.52

Use four connectors (6606) to connect equal crosses (RA07 40 00, RA07 50 00, and RA07 63 00) to Transair® Ø 1 1/2", Ø 2", and Ø 2 1/2" pipes.

Use four connectors (RR01) to connect equal crosses (RA07 L1 00, RA07 L3 00, and RA07 L8 00) to Transair® Ø 3", Ø 4", and Ø 6" pipes.

**Diameter: 1" to 1-1/2"**

**Plug-In Reducer**

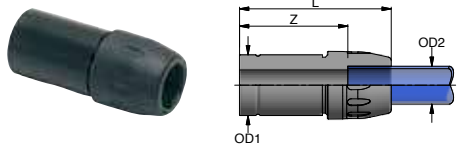

PART NO.	OD1 (IN)	OD1 (MM)	OD2 (IN)	OD2 (MM)	L (IN)	Z (IN)
6666 17 25	1	25	1/2	16.5	3.05	2.03
6666 25 40	1 1/2	40	1	25	3.96	2.81

**Diameter: 2" to 2-1/2"**

**Plug-In Reducer**

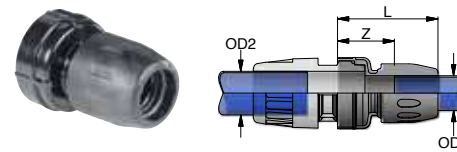

PART NO.	OD1 (IN)	OD1 (MM)	OD2 (IN)	OD2 (MM)	L (IN)	Z (IN)
6666 25 50	1	25	2	50	3.82	2.76
6666 40 63	1 1/2	40	2 1/2	63	4.72	2.95
6666 40 50	1 1/2	40	2	50	4.57	2.60
6666 50 63	2	50	2 1/2	63	4.92	2.56

**Diameter: 3" to 6"**

**Plug-In Reducer**

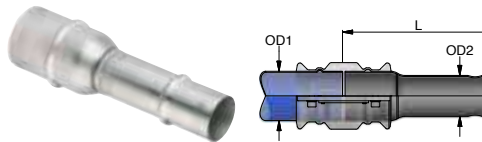

**Stainless Steel**

PART NO.	OD1 (IN)	OD1 (MM)	OD2 (IN)	OD2 (MM)	L (IN)
RX64 L1 50	3	76	2	50	8.67
RX64 L1 63	3	76	2 1/2	63	9.06
RX64 L3 50	4	101	2	50	13.50
RX64 L3 63	4	101	2 1/2	63	9.84
RX66 L3 L1	4	101	3	76	7.58

Use one connector (RR01) to connect plug-in reducers (RX64 and RX66) to Transair® Ø 3" or Ø 4" pipes and one connector (6606) to connect to Transair® Ø 2 1/2" pipe.

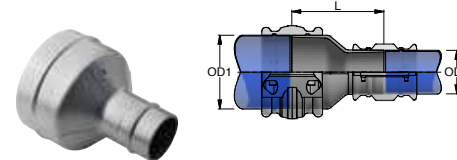

**Cast Aluminum**

PART NO.	OD1 (IN)	OD1 (MM)	OD2 (IN)	OD2 (MM)	L (IN)
RA66 L8 L3	6	168	4	101	8.27
RA66 L8 L1	6	168	3	76	8.27

Use two connectors (RR01) to connect plug-in reducers (RA66) to Transair® pipe.

**WARNING:** This product can expose you to chemicals including Lead and Lead Compounds which is known to the State of California to cause cancer and birth defects or other reproductive harm. For more information go to [www.P65Warnings.ca.gov](http://www.P65Warnings.ca.gov)



**Diameter: 1/2" to 1-1/2"**

**Vented End Cap**

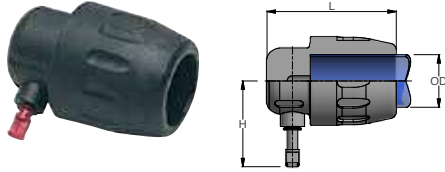

PART NO.	OD (IN)	OD (MM)	L (IN)	Z (IN)
6625 17 00	1/2	16.5	2.46	1.79
6625 25 00	1	25	2.95	1.85
6625 40 00	1 1/2	40	3.94	2.13

Model Ø 16.5: supplied with LF3000 6mm plug. Models Ø25 and Ø40: supplied with LF3000 8mm plug.

**Diameter: 2" to 2-1/2"**

**Vented End Cap**

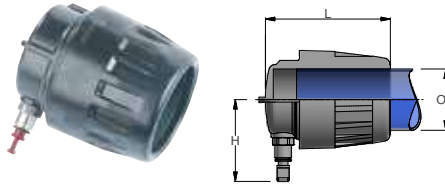

PART NO.	OD (IN)	OD (MM)	L (IN)	Z (IN)
6625 50 00	2	50	4.21	2.64
6625 63 00	2 1/2	63	4.37	2.85

Ø 1/2": supplied with LF3000 8mm plug. Model Ø", Ø 1 1/2", Ø 2" and Ø 2 1/2": supplied with LF3000 5/16" plug.

**Diameter: 3" to 6"**

**End Cap**

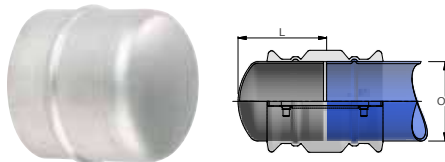

PART NO.	OD (IN)	OD (MM)	L (IN)
RX25 L1 00	3	76	4.17
RX25 L3 00	4	101	4.23

Use one connector (RR01) to connect end caps (RX25) to Transair® pipe.

**Diameters: 3" to 6"**

**End Cap with Plug**

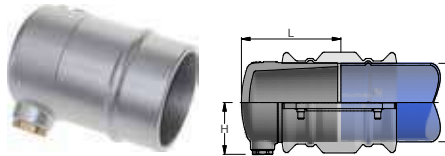

PART NO.	OD (IN)	OD (MM)	L (IN)	Z (IN)
RA25 L1 04	3	76	4.84	1.89
RA25 L3 04	4	101	4.84	2.40
RA25 L8 04	6	168	4.56	3.21

End cap Plug is 1/2" BSP.

Use one connector (RR01) to connect end caps (RA25) to Transair pipe.

**Diameter: 1/2" to 1-1/2"**

**Male Threaded NPT Connector**

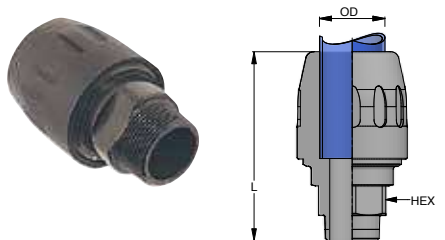

PART NO.	OD (IN)	OD (MM)	THD SIZE (IN)	HEX (MM)	L (IN)
6605 17 14	1/2	16.5	1/4	20	2.52
6605 17 22	1/2	16.5	1/2	24	2.64
6605 25 22	1	25	1/2	30	2.81
6605 25 28	1	25	3/4	30	2.81
6605 25 35	1	25	1	38	2.95
6605 40 35	1 1/2	40	1	41	4.53
6605 40 43	1 1/2	40	1 1/4	41	4.51
6605 40 50	1 1/2	40	1 1/2	50	4.63
6605 40 44	1 1/2	40	2	70	4.73

**WARNING:** This product can expose you to chemicals including Lead and Lead Compounds which is known to the State of California to cause cancer and birth defects or other reproductive harm. For more information go to [www.P65Warnings.ca.gov](http://www.P65Warnings.ca.gov)

Diameter: 2" to 2-1/2"

Male Threaded NPT Connector

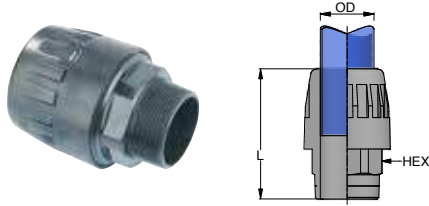

PART NO.	OD (IN)	OD (MM)	THD SIZE (IN)	HEX (MM)	L (IN)
6605 50 50	2	50	1 1/2	50	4.65
6605 50 44	2	50	2	60	4.76
6605 63 44	2 1/2	63	2	70	4.65
6605 63 41	2 1/2	63	2 1/2	80	5.51
6605 63 46	2 1/2	63	3	80	5.49

Diameter: 1" to 2-1/2"

Male Threaded NPT Stud Adapter

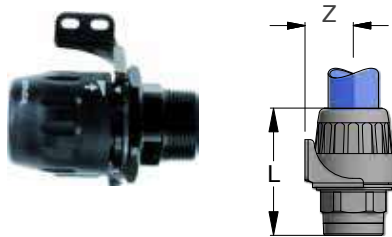

PART NO.	OD (IN)	OD (MM)	THD SIZE (IN)	HEX (MM)	L (IN)	Z (IN)
6615 25 22	1	25	1/2	27	3.60	1.81
6615 25 28	1	25	3/4	27	3.60	1.81
6615 25 35	1	25	1	34	3.76	1.81
6615 40 43	1 1/2	40	1 1/4	50	4.76	1.81
6615 40 50	1 1/2	40	1 1/2	50	4.76	1.81
6615 50 50	2	50	1 1/2	50	4.96	3.54
6615 50 44	2	50	2	60	4.96	3.54

Diameter: 1/2" to 2-1/2"

Male Threaded NPT Stud Nut

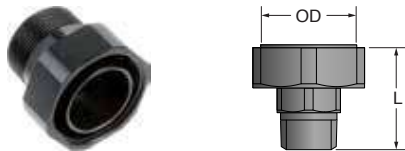

PART NO.	OD (IN)	OD (MM)	THREAD (NPT)	HEX 1 (MM)	HEX 2 (MM)	L (IN)
6611 17 22	1/2	16.5	1/2	32	23	1.65
6611 25 22	1	25	1/2	46	27	1.71
6611 25 28	1	25	3/4	46	27	1.72
6611 25 35	1	25	1	46	36	1.93
6611 40 35	1 1/2	40	1	65	41	2.11
6611 40 43	1 1/2	40	1 1/4	65	50	2.34
6611 40 50	1 1/2	40	1 1/2	65	50	2.36
6611 40 44	1 1/2	40	2	65	60	2.56
6611 50 44	2	50	2	-	60	3.19
6611 50 50	2	50	1 1/2	-	60	3.07
6611 63 44	2 1/2	63	2	-	70	3.05
6611 63 41	2 1/2	63	2 1/2	-	80	3.53

Diameter: 1/2" to 1-1/2"

Male Threaded NPT Adapter

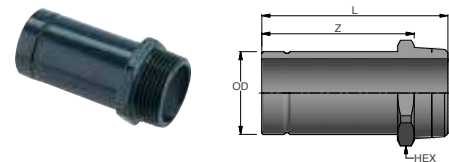

PART NO.	OD (IN)	OD (MM)	THREAD (NPT)	HEX (MM)	L (IN)	Z (IN)
6621 17 22	1/2	16.5	1/2	24	2.26	1.66
6621 25 22	1	25	1/2	28	2.53	1.93
6621 25 28	1	25	3/4	28	2.57	1.93
6621 25 35	1	25	1	36	2.80	2.05
6621 40 43	1 1/2	40	1 1/4	46	3.75	2.90
6621 40 50	1 1/2	40	1 1/2	50	3.84	2.98

**WARNING:** This product can expose you to chemicals including Lead and Lead Compounds which is known to the State of California to cause cancer and birth defects or other reproductive harm. For more information go to [www.P65Warnings.ca.gov](http://www.P65Warnings.ca.gov)

**Diameter: 3"**

**Male Threaded NPT Adapter**

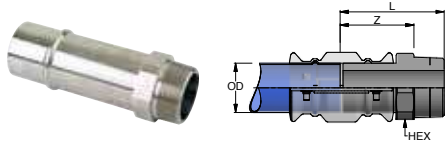

PART NO.	OD (IN)	OD (MM)	L (IN)	THD SIZE (IN)	HEX (MM)
RR21 L1N20	3	76	5.08	2 1/2	80
RR21 L1N24	3	76	5.31	3	95

**Diameter: 1" to 1-1/2"**

**4 Port Manifolds**

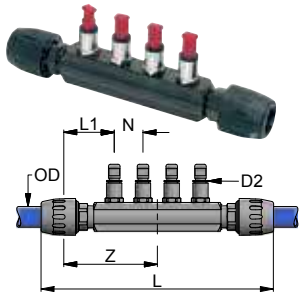

PART NO.	OD (IN)	OD (MM)	L (IN)	Z (IN)	L1 (IN)	N (IN)
6651 25 12 04	1	25	10.83	4.29	1.25	1.38
6651 40 12 04	1 1/2	40	15.87	6.02	1.89	1.97

Supplied with four Ø12 mm plugs. 1" supplied with 3/8" BSPP ports. 1 1/2" supplied with 1/2" BSPP ports.

**Diameter: 1" to 1-1/2"**

**6 Port Manifolds**

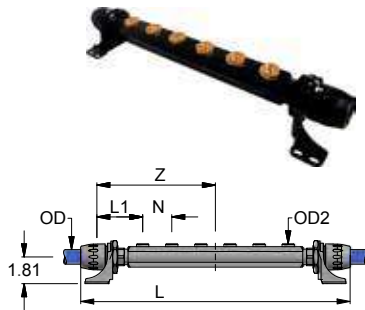

PART NO.	OD (IN)	OD (MM)	L (IN)	Z (IN)	L1 (IN)	N (IN)	K (IN)
6653 25 22 06	1	25	18.23	8.03	2.13	1.97	16.81
6653 40 22 06	1 1/2	40	20.71	8.54	2.44	1.97	17.64

Supplied with 1/2" NPT ports.

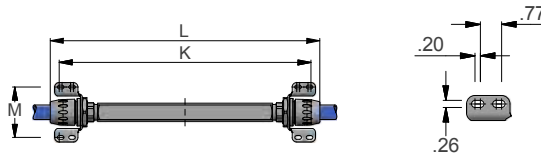

**Diameter: 2-1/2" to 6"**

**Flange**

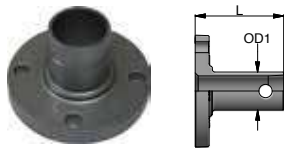

**Cast Aluminum**

PART NO.	OD (IN)	OD (MM)	L (IN)	STANDARD
RA30 63 00	2 1/2	63	5.77	DIN
RA31 63 00	2 1/2	63	5.77	ANSI
RA30 L1 00	3	76	4.20	DIN
RA31 L1 00	3	76	4.20	ANSI
RA30 L3 00	4	101	4.20	DIN
RA31 L3 00	4	101	4.20	ANSI
RA31 L8 00	6	168	5.02	ANSI

Use one connector (6606) to connect flanges (RA30 63 00 and RA31 630 00) to Transair Ø 2 1/2" pipe.

Use one connector (RR01) to connect flanges (RA30 and RA31) to Transair Ø 3", Ø 4", and Ø 6" pipes.

**WARNING:** This product can expose you to chemicals including Lead and Lead Compounds which is known to the State of California to cause cancer and birth defects or other reproductive harm. For more information go to [www.P65Warnings.ca.gov](http://www.P65Warnings.ca.gov)

Diameter: 6"

Flange Reducer

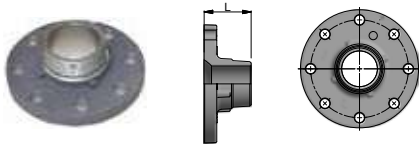

PART NO.	OD1 (IN)	OD1 (MM)	OD2 (IN)	OD2 (MM)	L (IN)	STANDARD
RA31 L8 K2	8	203.2	6	168	7.85	ANSI

Use one connector (RR01) to connect flange reducer (RA31) to Transair pipe.

Diameter: 3" to 4"

Aluminum Male Threaded NPT Flange Adapter

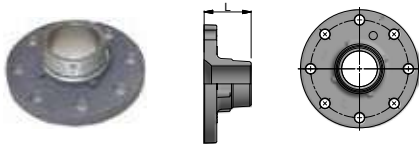

PART NO.	OD (IN)	OD (MM)	L (IN)	THD SIZE (IN)
RA33 L1N24	3	76	3.61	3
RA33 L3N24	4	101	3.61	3

RA33 are ANSI standard flanges

Diameter: 2-1/2" to 6"

Flange Gasket



PART NO.	OD (IN)	OD (MM)	FOR USE WITH FLANGE REFERENCE
EW05 63 00	2 1/2	63	RA30 63 00
EW05 L1 00	3	76	RX30/RX31 L1 00
EW05 L3 00	4	101	RX30/RX31 L3 00
EW05 L8 00	6	168	RA31 L8 00

Diameter: 2-1/2" to 6"

Bolt Kit



PART NO.	OD (IN)	OD (MM)	THD SIZE (IN)	L (IN)	HEX
EW06 00 10	2 1/2, 3, 4	63, 76, 101	5/8-11	3.50	15/16 IN
EW06 00 11	3	76	5/8-11	5.25	15/16 IN
EW06 00 12	6	168	3/4-10	3.75	1 3/4 IN
EW06 00 01	3,4	76, 101	M16 X 2	2.36	24 MM

Selection Chart

PART NO.	OD (IN)	OD (MM)	GASKET PART NO.	BOLT KIT PART NO. (FLANGE TO FLANGE)	NUMBER OF KITS	MAX. TIGHTENING TORQUE (FT-LBS)
RA30 63 00	2-1/2	63	EW05 63 00	EW06 00 10	1	59
RA31 63 00	2-1/2	63	EW05 63 00	EW06 00 10	1	59
RA30 L1 00	3	76	EW05 L1 00	EW06 00 10	1	59
RA31 L1 00	3	76	EW05 L1 00	EW06 00 10	1	59
RA30 L3 00	4	101	EW05 L3 00	EW06 00 10	1	59
RA31 L3 00	4	101	EW05 L3 00	EW06 00 10	1	59
RA31 L8 00	6	168	EW05 L8 00	EW06 00 12	2	147
RA31 L8 K2	6	168	EW05 L8 00	EW06 00 12	2	147
RA33 L1N24	3	76	EW05 L1 00	EW06 00 10	1	59
RA33 L3N24	4	101	EW05 L3 00	EW06 00 10	1	59
RX30 L1 00	3	76	EW05 L1 00	EW06 00 01	1	59
RX31 L1 00	3	76	EW05 L1 00	EW06 00 01	1	59
RX30 L3 00	4	101	EW05 L3 00	EW06 00 01	1	59
RX31 L3 00	4	101	EW05 L3 00	EW06 00 01	1	59

**WARNING:** This product can expose you to chemicals including Lead and Lead Compounds which is known to the State of California to cause cancer and birth defects or other reproductive harm. For more information go to [www.P65Warnings.ca.gov](http://www.P65Warnings.ca.gov)

# Drop Brackets

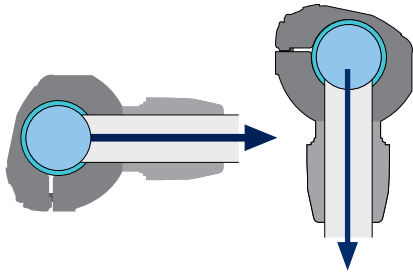

For rigid drops with horizontal take off or for all types of air supply with rigid pipe or flexible hose on an installation which incorporates an efficient air dryer.

### Product Features:

- Optimum flow
- Compact
- Well adapted for most original equipment manufacturer (OEM) applications and for use with neutral gases
- Quick installation without any cutting of pipe

## Diameter: 1" to 2"

### Simple Reducing Bracket

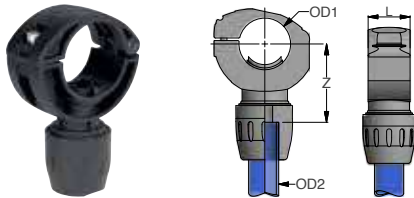

PART NO.	OD1 (IN)	OD1 (MM)	OD2 (IN)	OD2 (MM)	L (IN)	Z (IN)
RA69 25 17	1	25	1/2	16.5	1.46	1.76
RA69 40 25	1 1/2	40	1	25	1.46	1.77
RA69 50 25	2	50	1	25	1.46	1.30
RA69 63 25	2 1/2	63	1	25	1.46	1.45

To drill Transair® pipe, use drilling tools 6698 02 01 and 6698 02 02.

## Diameter: 1" to 2"

### Threaded NPT Simple Bracket

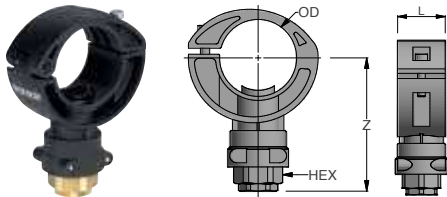

PART NO.	OD (IN)	OD (MM)	THD SIZE (IN)	L (IN)	HEX (MM)	Z (IN)
RA68 25N04	1	25	1/2	1.46	30	2.60
RA68 40N04	1 1/2	40	1/2	1.46	30	2.87
RA68 50N04	2	50	1/2	1.46	30	3.27
RA68 50N08	2	50	1	1.46	41	3.82
RA68 63N08	2 1/2	63	1	1.46	41	4.02

Supplied with brass plug. To drill Transair® pipe, use drilling tools 6698 02 01 and 6698 02 02.

## Diameters: 3" to 4"

### Saddle Reducing Bracket – Threaded Female NPT

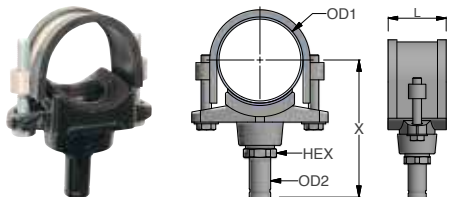

PART NO.	OD (IN)	OD (MM)	OD2 (IN)	OD2 (MM)	L (IN)	X (IN)	HEX (MM)
RR63 L1N08	3	76	1	25	3.15	5.71	36
RR63 L3N08	4	101	1	25	3.54	6.30	36

Nitrile Seals. Supplied with Ø 1" adaptor (6621 25 35). To drill Transair® pipe, use drilling tool EW09.

**WARNING:** This product can expose you to chemicals including Lead and Lead Compounds which is known to the State of California to cause cancer and birth defects or other reproductive harm. For more information go to [www.P65Warnings.ca.gov](http://www.P65Warnings.ca.gov)

Diameters: 6"

Saddle Reducing Bracket

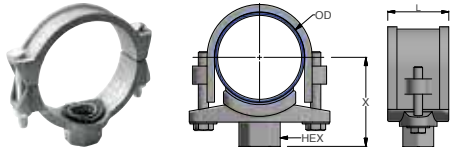

PART NO.	OD (IN)	OD (MM)	THD SIZE 1 (IN)	THD SIZE 2 (IN)	L (IN)
RR63 L8N12	6	168	1 1/2	16	9 1/4
RR63 L8N16	6	168	2	16	9 1/4

Diameter: 1" to 1-1/2"

Quick Assembly Bracket

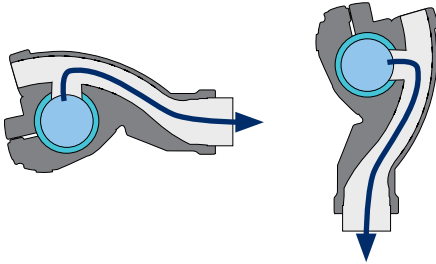

New generation quick assembly brackets are recommended for vertical or horizontal take-offs, using either rigid pipe or flexible hose.

Product Features:

- Integral water retention device
- Very high flow
- Quick installation without any cutting of pipe

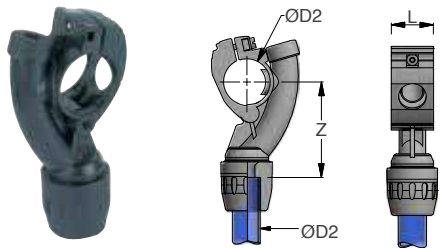

PART NO.	OD1 (IN)	OD1 (MM)	OD2 (IN)	OD2 (MM)	L (IN)	Z (IN)
6662 25 17	1	25	1/2	16.5	1 7/16	3 1/4
6662 25 00	1	25	1	25	1 7/16	3
6662 40 17	1 1/2	40	1/2	16.5	1 1/2	3 1/2
6662 40 25	1 1/2	40	1	25	1 1/2	3 1/4

To drill Transair® pipe, use drilling tools 6698 02 01 and 6698 02 02.

Diameter: 2" to 2-1/2"

Quick Assembly Bracket

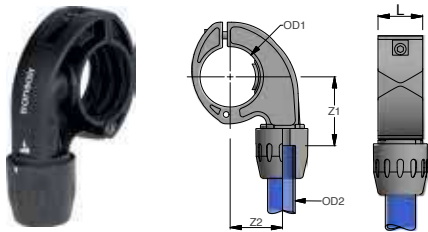

PART NO.	OD1 (IN)	OD1 (MM)	OD2 (IN)	OD2 (MM)	L (IN)	Z1 (IN)	Z2 (IN)
6662 50 25	2	50	1	25	1.46	2.28	1.73
6662 63 25	2 1/2	63	1	25	1.46	2.56	1.73

To drill Transair® pipe, use drilling tool 6698 02 01.

Diameter: 1" to 1-1/2"

Female Threaded NPT Quick Assembly Mini-Bracket

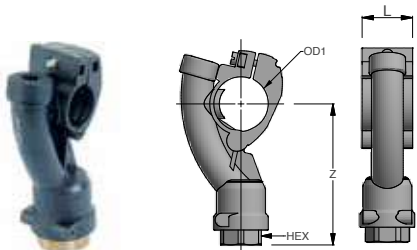

PART NO.	OD1 (IN)	OD1 (MM)	THD SIZE (IN)	HEX (MM)	L (IN)	Z (IN)
6663 25 22	1	25	1/2	24	1.46	3.80
6663 40 22	1 1/2	40	1/2	24	1.46	4.09

Supplied with brass plug. To drill Transair® pipe, use drilling tools 6698 02 01 and 6698 02 02.

**WARNING:** This product can expose you to chemicals including Lead and Lead Compounds which is known to the State of California to cause cancer and birth defects or other reproductive harm. For more information go to [www.P65Warnings.ca.gov](http://www.P65Warnings.ca.gov)

**Diameter: 2" to 2-1/2"**

**Female Threaded NPT Quick Assembly Mini-Bracket**

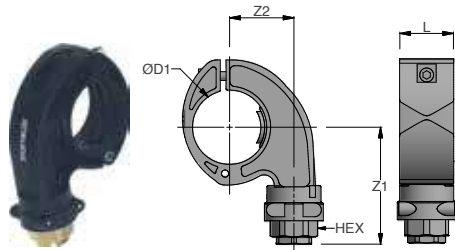

PART NO.	OD1 (IN)	OD1 (MM)	THD SIZE (IN)	HEX (MM)	L (IN)	Z (IN)
6663 50 22	2	50	1/2	30	1.46	2.95
6663 50 28	2	50	3/4	32	1.46	3.31
6663 63 22	2 1/2	63	1/2	30	1.46	3.23
6663 63 28	2 1/2	63	3/4	32	1.46	3.58

Supplied with brass plug. To drill Transair® pipe, use drilling tool 6698 02 01.

**Diameter: 1" to 2-1/2"**

**Threaded NPT Quick Assembly Bracket with Ball Valve**

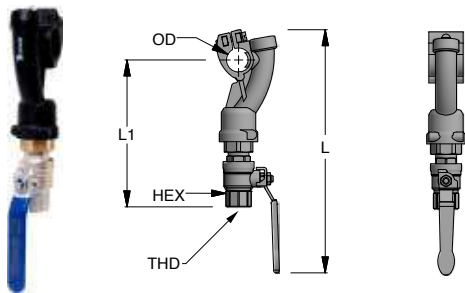

PART NO.	OD (IN)	OD (MM)	THD SIZE (IN)	HEX (MM)	L (IN)	L1 (IN)
6668 25 22	1	25	1/2	25	10.08	6.10
6668 40 22	1 1/2	40	1/2	25	10.67	6.38
6668 50 22	2	50	1/2	25	9.76	5.22
6668 63 22	2 1/2	63	1/2	25	10.40	5.53
6668 63 28	2 1/2	63	3/4	31	11.69	6.08

To drill Transair® pipe, use drilling tools 6698 02 01 and 6698 02 02.

**Drill Bit Selection Chart for Drop Brackets**

PART NO.	OD (IN)	OD (MM)	TOOL PART NO.
RA69 25 17	1	25	6698 02 02
RA69 40 25	1 1/2	40	6698 02 01
RA69 50 25	2	50	6698 02 01
RA69 63 25	2 1/2	63	6698 02 01
RA68 25N04	1	25	6698 02 02
RA68 40N04	1 1/2	40	6698 02 01
RA68 50N04	2	50	6698 02 01
RA68 50N08	2	50	6698 02 01
RA68 63N08	2 1/2	63	6698 02 01
RR63 L1N08	3	76	EW09 00 30
RR63 L3N08	4	101	EW09 00 30
RR63 L8N12	6	168	EW09 00 51
RR63 L8N16	6	168	EW09 00 64
6662 25 17	1	25	6698 02 02
6662 25 00	1	25	6698 02 02

PART NO.	OD (IN)	OD (MM)	TOOL PART NO.
6662 40 17	1 1/2	40	6698 02 01
6662 40 25	1 1/2	40	6698 02 01
6662 50 25	2	50	6698 02 01
6662 63 25	2 1/2	63	6698 02 01
6663 25 22	1	25	6698 02 02
6663 40 22	1 1/2	40	6698 02 01
6663 50 22	2	50	6698 02 01
6663 50 28	2	50	6698 02 01
6663 63 22	2 1/2	63	6698 02 01
6663 63 28	2 1/2	63	6698 02 01
6668 25 22	1	25	6698 02 02
6668 40 22	1 1/2	40	6698 02 01
6668 50 22	2	50	6698 02 01
6668 63 22	2 1/2	63	6698 02 01
6668 63 28	2 1/2	63	6698 02 01

**WARNING:** This product can expose you to chemicals including Lead and Lead Compounds which is known to the State of California to cause cancer and birth defects or other reproductive harm. For more information go to [www.P65Warnings.ca.gov](http://www.P65Warnings.ca.gov)

# Pressurized System Outlets

We recommend, however, that the pipe system is vented prior to the addition of an outlet. Thanks to the lateral dismantling capability of Transair® pipe and the use of quick assembly brackets, this operation can be completed very quickly (less than seven minutes for a new outlet) and guarantees the interior cleanliness of the system.

### Product Features:

- Ideal for fast assembly of new pressurized outlets, without venting the compressed air system.
- The drilling tool can be used with most standard drills.

Diameter: 1" to 2-1/2"

### Pressurized System Bracket

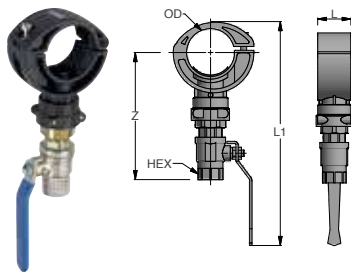

PART NO.	OD (IN)	OD (MM)	L (IN)	L1 (IN)	Z (IN)
EA98 25 04	1	25	1.46	8.27	4.57
EA98 40 04	1 1/2	40	1.46	8.82	4.80
EA98 50 04	2	50	1.46	9.41	5.24
EA98 63 04	2 1/2	63	1.46	9.88	5.43

Bracket with ball valve (1/2" BSPP thread)  
 Drilling tool EA98 06 00 is required for installation  
 For installation instructions see page E26

### Pressurized System Drilling Tool, BSPP

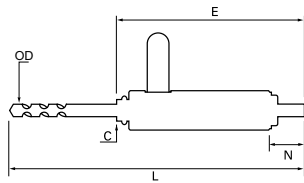

PART NO.	OD (IN)	OD (MM)	C (IN)	L (IN)
EA98 06 00	1/2	16.5	1/2	13

**WARNING:** This product can expose you to chemicals including Lead and Lead Compounds which is known to the State of California to cause cancer and birth defects or other reproductive harm. For more information go to [www.P65Warnings.ca.gov](http://www.P65Warnings.ca.gov)



# Wall Brackets

## Product Features:

- 1, 2 or 3 ports
- For wall or machine mounting
- Supplied with brass plugs
- Drain outlet 1/4"
- Non-flammable (conforms to UL94-HB standard)

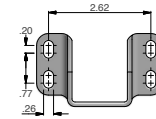

Dimensions for all brackets.

### Diameter: 1/2" to 1"

### 1 Port 45° Wall Bracket – Threaded NPT Port

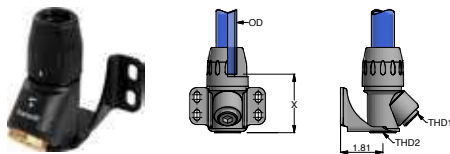

PART NO.	OD (IN)	OD (MM)	THREAD 1 (NPT)	THREAD 2 (NPT)	X (IN)	Z (IN)
6640 17 22	1/2	16.5	1/2	1/4	2.50	2 1/2
6640 25 22	1	25	1/2	1/4	2.50	2 1/2

### Diameter: 1/2"

### Threaded NPT 1 Port 45° Wall Bracket

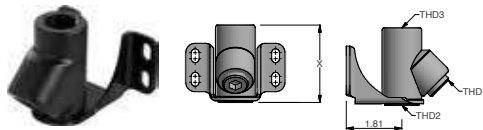

PART NO.	THD SIZE 1 (IN)	THD SIZE 2 (IN)	THD SIZE 3 (IN)	X (IN)
6642 22 22	1/2	1/4	1/2	2.52

### Diameter: 1/2" to 1"

### 2 Port 45° Wall Bracket – Threaded NPT Port

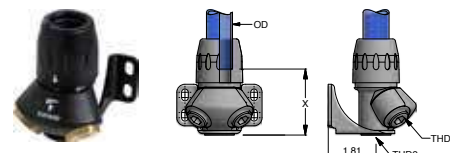

PART NO.	OD (IN)	OD (MM)	THD SIZE 1 (IN)	THD SIZE 2 (IN)	L (IN)	X (IN)
6689 17 22	1/2	16.5	1/2	1/4	2.50	2 1/2
6689 25 22	1	25	1/2	1/4	2.52	2 1/2

### Diameter: 1/2"

### Threaded NPT 2 Port 45° Wall Bracket

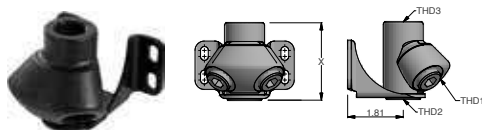

PART NO.	THD SIZE 1 (IN)	THD SIZE 2 (IN)	THD SIZE 3 (IN)	X (IN)
6691 22 22	1/2	1/4	1/2	2.52

### Diameter: 1/2" to 1"

### 2 Port 90° Wall Bracket – Threaded NPT Port

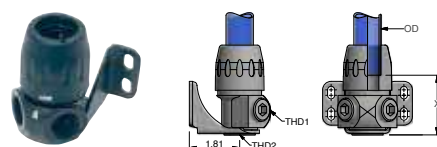

PART NO.	OD (IN)	OD (MM)	THD SIZE 1 (IN)	THD SIZE 2 (IN)	X (IN)
6684 17 22	1/2	16.5	1/2	1/4	2.05
6684 25 22	1	25	1/2	1/4	2.22

**WARNING:** This product can expose you to chemicals including Lead and Lead Compounds which is known to the State of California to cause cancer and birth defects or other reproductive harm. For more information go to [www.P65Warnings.ca.gov](http://www.P65Warnings.ca.gov)

Diameter: 1/2"

Threaded NPT 2 Port 90° Wall Bracket

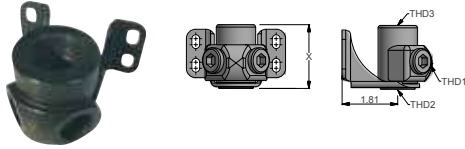

PART NO.	THD SIZE 1 (IN)	THD SIZE 2 (IN)	THD SIZE 3 (IN)	X (IN)
6688 22 22	1/2	1/4	1/2	2.03

Diameter: 1"

3 Port Wall Bracket – Threaded NPT Port

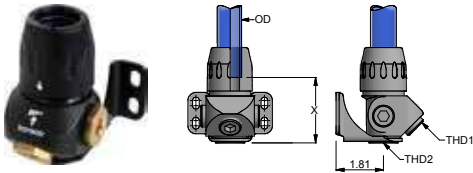

PART NO.	OD (IN)	OD (MM)	THD SIZE 1 (IN)	THD SIZE 2 (IN)	X (IN)
6696 25 22	1	25	1/2	1/4	2.52

Diameter: 3/4"

Threaded NPT 3 Port Wall Bracket

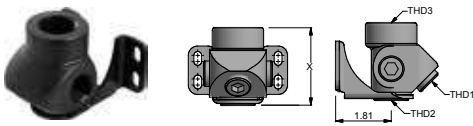

PART NO.	THD SIZE 1 (IN)	THD SIZE 2 (IN)	THD SIZE 3 (IN)	X (IN)
6636 28 22	1/2	1/4	3/4	2.52

Diameter: 1/2" to 1"

1 Port 45° Wall Bracket With Ball Valve – Threaded NPT Port

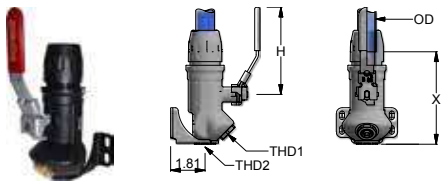

PART NO.	OD (IN)	OD (MM)	THD SIZE 1 (IN)	THD SIZE 2 (IN)	X (IN)	H (IN)
6679 17 22	1/2	16.5	1/2	1/4	4.09	3.77
6679 25 22	1	25	1/2	1/4	4.86	4.59

Diameter: 1/2" to 1"

2 Port 45° Wall Bracket With Ball Valve – Threaded NPT Port

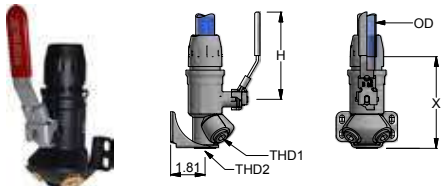

PART NO.	OD (IN)	OD (MM)	THD SIZE 1 (IN)	THD SIZE 2 (IN)	X (IN)	H (IN)
6694 17 22	1/2	16.5	1/2	1/4	4.09	3.77
6694 25 22	1	25	1/2	1/4	4.86	4.59

Diameter: 1/2" to 1"

3 Port Wall Bracket With Ball Valve – Threaded NPT port

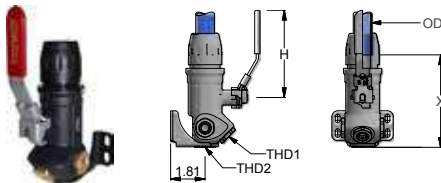

PART NO.	OD (IN)	OD (MM)	THD SIZE 1 (IN)	THD SIZE 2 (IN)	X (IN)	H (IN)
6638 25 22	1	25	1/2	1/4	4.86	4.59

**WARNING:** This product can expose you to chemicals including Lead and Lead Compounds which is known to the State of California to cause cancer and birth defects or other reproductive harm. For more information go to [www.P65Warnings.ca.gov](http://www.P65Warnings.ca.gov)

# Valves

Transair® ball valves and butterfly valves placed regularly throughout the system at key locations, such as compressor outlets and upstream of pneumatic tools, allow ease of system isolation and pipe reconfiguration / maintenance.

## Product Features:

- Quick connection
- Lockable handles

## Specifications:

**Max. Working Pressure\*** 188 PSI from -4°F to +140°F (12.9 bar from -20° to +60° C)  
 232 PSI from -4°F to +115°F (15.9 bar from -20° to +46.1° C)

**Vacuum:** 98.7% (29.6" Hg)

**Working Temperature:** -4° to +140° F (-20° to +60° C)

\* Please consult us for higher temperature requirements

### Diameters: 1/2" to 1-1/2" Lockable Double Female Valve

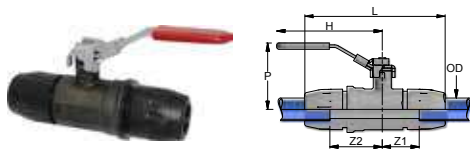

PART NO.	OD (IN)	OD (MM)	L (IN)	Z1 (IN)	Z2 (IN)	H (IN)	P (IN)
4092 17 00	1/2	16.5	4.84	1.14	1.69	3.77	2.01
4092 25 00	1	25	6.10	1.61	2.24	4.61	2.87
4092 40 00	1 1/2	40	8.07	2.20	2.28	5.55	2.99

### Diameters: 2" to 2-1/2" Lockable Double Female Valve

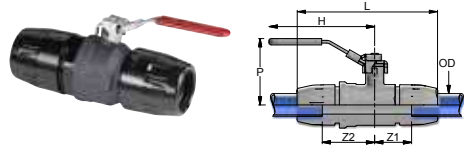

PART NO.	OD (IN)	OD (MM)	L (IN)	Z1 (IN)	Z2 (IN)	H (IN)	P (IN)
4092 50 00	2	50	8.96	2.36	1.69	6.14	3.54
4092 63 00	2 1/2	63	10.59	2.60	3.03	7.87	4.29

### Diameters: 3" to 6" Ball Valve

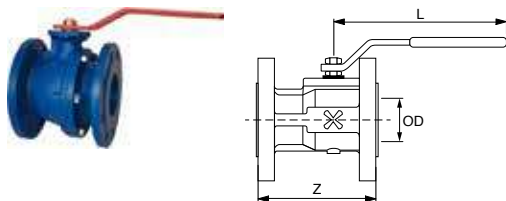

PART NO.	OD (IN)	OD (MM)	L (IN)	Z (IN)	STANDARD
VR01 L1 00 46	3	76	11.02	7.09	ANSI
VR01 L3 00 46	4	101	14.17	7.48	ANSI
VR01 L8 00	6	168	20.47	8.27	ANSI

## Ball Valve Accessories Chart

PART NO.	OD (IN)	OD (MM)	BALL VALVE PART NO.	GASKET PART NO.	BOLT KIT PART NO. (FLANGE TO BALL VALVE)	NUMBER OF KITS	MAX. TIGHTENING TORQUE (FT-LBS)
RA30 L1 00	3	76	VR01 L1 46	EW05 L1 00	EW06 00 01	1	59
RA31 L3 00	4	101	VR01 L3 46	EW05 L3 00	EW06 00 01	2	59
RA31 L8 00	6	168	VR01 L8 00	EW05 L8 00	EW06 00 12	4	147

**WARNING:** This product can expose you to chemicals including Lead and Lead Compounds which is known to the State of California to cause cancer and birth defects or other reproductive harm. For more information go to [www.P65Warnings.ca.gov](http://www.P65Warnings.ca.gov)

Diameters: 3" to 6"

Butterfly Valve

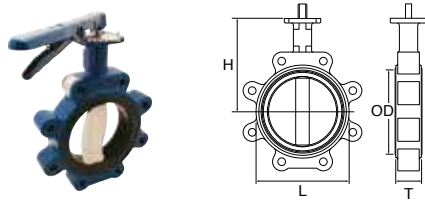

PART NO.	OD (IN)	OD (MM)	L (IN)	H (IN)	T (IN)	NUMBER OF LUGS
VR02 63 00	2 1/2	63	4.13	5.98	1.75	4
VR02 L1 00US	3	76	4.72	6.30	1.75	4
VR02 L3 00US	4	101	5.91	7.09	2.00	6
VR02 L8 00US	6	168	8.07	8.07	2.12	8

Valve is not supplied with handle and bolt kit.  
Max. Pressure 175 PSI (12 bar)

Lockable Valve Handle



PART NO.	VALVE DIAMETER (IN)
EW08 L1 00	3
EW08 L3 01	4
EW08 L8 00	6

Bolt Kit



PART NO.	OD (IN)	OD (MM)	THD SIZE (IN)	L (IN)	HEX (IN)
EW10 00 01	3,4	76, 101	5/8-11	1.25	15/16
EW10 00 US	3,4	76, 101	5/8-11	1.75	15/16
EW10 00 02	6	168	3/4-10	2.00	1 3/4

EW10 00 01 for use with stainless steel flanges.  
EW10 00 US for use with aluminum flanges.

Butterfly Valve Accessories Chart

PART NO.	OD (IN)	OD (MM)	BUTTERFLY VALVE PART NO.	GASKET PART NO.	BOLT KIT PART NO. (FLANGE TO BUTTERFLY VALVE)	NUMBER OF KITS	MAX. TIGHTENING TORQUE (FT-LBS)
RA30 L1 00	3	76	VR01 L1 00	EW05 L1 00	EW06 00 01	1	59
RA31 L3 00	4	101	VR01 L3 00	EW05 L3 00	EW06 00 01	N/A	59
RA31 L8 00	6	168	VR01 L8 00	EW05 L8 00	EW06 00 12	4	147

Diameter: 1-1/2"

Remote Control Shut-Off Valve

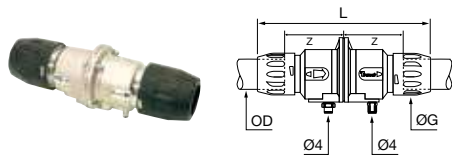

PART NO.	OD (IN)	OD (MM)	L (IN)	Z (IN)
4230 00 40	1 1/2	40	10 1/4	3 3/8

Min. working pressure: 58 PSI • Max. working pressure: 232 PSI. The Transair® remote control shut-off valve is supplied with a plugged vent hole. This allows venting of the downstream network, after closing the valve. Pilot kit (4299 03 01) is needed for installation. Refer to page E18 for installation instructions

Pilot Kit



PART NO.	H (IN)	L (IN)
4299 03 01	5 3/4	3 3/16

This pilot kit includes: pneumatic ON/OFF switch (maximum 232 PSI operating pressure), twin 4 mm OD polyurethane tube (length 10 m) and plastic box. Refer to page E18 for installation instructions

**WARNING:** This product can expose you to chemicals including Lead and Lead Compounds which is known to the State of California to cause cancer and birth defects or other reproductive harm. For more information go to [www.P65Warnings.ca.gov](http://www.P65Warnings.ca.gov)





# Transair<sup>®</sup> Tools





# Transair® Tools

## Product Features:

- Practical tools for the installation and extension of Transair® pipe systems.
- Presented in a carrying case or available as separate parts.

### Diameters: 1/2" to 2-1/2"

### Tool Case



PART NO.	H (IN)	L (IN)
6698 00 05	12 7/8	11 3/8

This tool case simplifies the use and transportation of tools. It contains all the tools necessary for completing system installations from 1/2" to 2-1/2":

- Chamfer tool 6698 04 01
- Cutter for rigid pipe 6698 03 01
- Deburring tool 6698 04 02
- Drilling jig 6698 01 03
- Drilling tools 6698 02 01 and 6698 02 02
- Marking tool 6698 04 03
- Spanner wrenches 6698 05 03

### Diameters: 1/2" to 6"

### Pipe Cutter

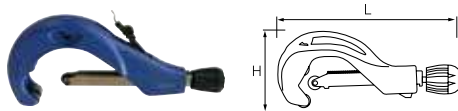

PART NO.	USED FOR TRANSAIR® PIPE (IN)
6698 03 01	Ø 1/2" - 3"
EW08 00 03	Ø 4" - 6"

- Includes deburring tool.

### Replacement cutter wheels



PART NO.	USED FOR TRANSAIR® PIPE (IN)
EW08 00 99	6698 03 01
EW08 00 04	EW08 00 03

### Diameters: 1/2" to 2-1/2"

### Drilling Jig for Rigid Aluminum Pipe



PART NO.
6698 01 03



PART NO.
6698 00 05

**WARNING:** This product can expose you to chemicals including Lead and Lead Compounds which is known to the State of California to cause cancer and birth defects or other reproductive harm. For more information go to [www.P65Warnings.ca.gov](http://www.P65Warnings.ca.gov)





**Diameters: 1" to 6"**

**Drilling Tool for Rigid Aluminum Pipe**

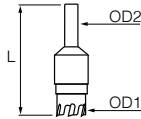

PART NO.	OD1 (IN)	OD1 (MM)	OD2 (IN)	OD2 (MM)	L (IN)	USED FOR TRANSAIR® PIPE (IN)
6698 02 02	5/8	16	1/2	11	2 7/8	Ø 1"

Drilling tool 6698 02 02 is required to install Ø 1" Transair® brackets. Recommended to be used with any cordless drill with a 1/2" chuck. Use with Transair drilling jig, 6698 01 03.

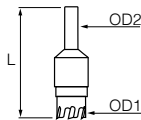

PART NO.	OD1 (IN)	OD1 (MM)	OD2 (IN)	OD2 (MM)	L (IN)	USED FOR TRANSAIR® PIPE (IN)
6698 02 01	1	22	1/2	13	2 3/4	Ø 1 1/2" - 2 1/2"

Drilling tool 6698 02 01 is required to install Ø 1 1/2" and Ø 2 1/2" Transair® brackets. It is also used to create the two holes needed for double-clamp ring connectors when cutting to length Ø 2 1/2" Transair® pipe. Recommended to be used with any cordless drill with a 1/2" chuck.

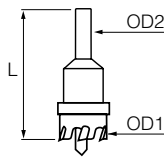

PART NO.	OD1 (IN)	OD1 (MM)	OD2 (IN)	OD2 (MM)	L (IN)	USED FOR TRANSAIR® PIPE (IN)
EW09 00 22	1	22	1/2	13	2 3/4	Ø 1 1/2" - 2 1/2"
EW09 00 30	1 3/16	30	1/2	13	2 3/4	Ø 3" - 4"
EW09 00 51	2	50	1/2	13	2 3/4	Ø 6"
EW09 00 64	2 1/2	63	1/2	13	2 3/4	Ø 6"

Drilling tool EW09 is required to install Transair® direct feed brackets. After drilling, it is important to deburr and clean the pipe. Recommended to be used with any cordless drill with a 1/2" chuck.

**Drilling Tool Selection Chart**

PART NO.	OD (IN)	OD (MM)	TOOL PART NO.
6650 00 00 04	2	50	6698 02 01
6650 00 00 16	2-1/2	63	6698 02 01
RA69 25 17	1	25	6698 02 02
RA69 40 25	1-1/2	40	6698 02 01
RA69 50 25	2	50	6698 02 01
RA69 63 25	2-1/2	63	6698 02 01
RA68 25N04	1	25	6698 02 02
RA68 40N04	1-1/2	40	6698 02 01
RA68 50N04	2	50	6698 02 01
RA68 50N08	2	50	6698 02 01
RA68 63N08	2-1/2	63	6698 02 01
RR63 L1N08	3	76	EW09 00 30
RR63 L3N08	4	101	EW09 00 30
RR63 L8N12	6	168	EW09 00 51
RR63 L8N16	6	168	EW09 00 64
6662 25 17	1	25	6698 02 02

PART NO.	OD (IN)	OD (MM)	TOOL PART NO.
6662 25 00	1	25	6698 02 02
6662 40 17	1-1/2	40	6698 02 01
6662 40 25	1-1/2	40	6698 02 01
6662 50 25	2	50	6698 02 01
6662 63 25	2-1/2	63	6698 02 01
6663 25 22	1	25	6698 02 02
6663 40 22	1-1/2	40	6698 02 01
6663 50 22	2	50	6698 02 01
6663 50 28	2	50	6698 02 01
6663 63 22	2-1/2	63	6698 02 01
6663 63 28	2-1/2	63	6698 02 01
6668 25 22	1	25	6698 02 02
6668 40 22	1-1/2	40	6698 02 01
6668 50 22	2	50	6698 02 01
6668 63 22	2-1/2	63	6698 02 01
6668 63 28	2-1/2	63	6698 02 01

**Deburring Tool for Rigid Aluminum Pipe**

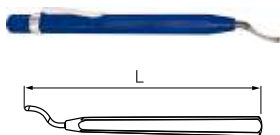

PART NO.
6698 04 02

**Chamfer Tool for Rigid Aluminum Pipe**



PART NO.
6698 04 01

For 1/2", 1" and 1 1/2".

**WARNING:** This product can expose you to chemicals including Lead and Lead Compounds which is known to the State of California to cause cancer and birth defects or other reproductive harm. For more information go to [www.P65Warnings.ca.gov](http://www.P65Warnings.ca.gov)

Diameters: 1/2" to 1-1/2"

Marking Tool for Rigid Aluminum Pipe

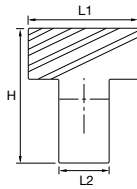
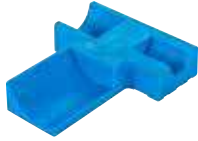

PART NO.
6698 04 03

The marking tool is used as a guide for marking cut lengths on Transair® pipe. These marks indicate the insertion limits of the pipe into each fitting in order to ensure a good airtight connection and secure grip.

2 to 2-1/2"

Spanner Wrenches



PART NO.
6698 05 03

Includes two tightening spanners. Used to tighten 50mm and 63mm connectors.

Pressurized System Drilling Tool, BSPP

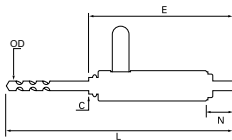

PART NO.	OD (IN)	OD (MM)	C (IN)	L (IN)
EA98 06 00	1/2	16.5	1/2	13

Portable Crimping Tool Kit



PART NO.	VOLTAGE
EW01 00 02	14

This case contains: one portable tool, one 14V battery and battery charger. Jaws sold separately.

Jaws for Portable Crimping Tool

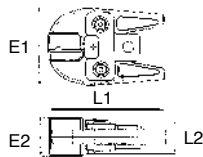

PART NO.	USED FOR TRANSAIR PIPE (IN)	USED FOR TRANSAIR PIPE (MM)
EW02 L1 00	3	76
EW02 L3 00	4	101
EW02 L8 00	6	168

14V Battery for Portable Crimping Tool



PART NO.	VOLTAGE
EW03 00 01	14

**WARNING:** This product can expose you to chemicals including Lead and Lead Compounds which is known to the State of California to cause cancer and birth defects or other reproductive harm. For more information go to [www.P65Warnings.ca.gov](http://www.P65Warnings.ca.gov)





# Transair<sup>®</sup> Accessories

Transair<sup>®</sup> Fixture Accessories

Hose Reels

Composite Automatic  
Safety Couplers





# Transair® Fixture Accessories

## Product Features:

- Easy adaptation for all pipe work configurations
- For suspension of pipes, from walls, partitions, beams, cable trays, Canalis electrical installations, etc, vertically or horizontally
- Perfectly suited for use with Transair® systems
- Non-flammable (conforms to UL94V-2 standard)
- Transair® fixing clips are designed to bear a maximum weight of 44lbs. However, to ensure good stability of the system, we recommend the use of at least two clips per pipe i.e.:
  - Maximum 5 ft space between clips for 9 ft lengths of pipe
  - Maximum 10 ft space between clips for 20 ft lengths of pipe
- Use only this clip for fixing Transair® rigid pipe, all other type of pipe clips are to be avoided. Fix the clip to a rigid support (U-channel, cable tray) to allow for expansion while retaining the pipe.

Installation information can be found on pages D32 through D35

### Diameters: 1/2" to 6"

### Fixing Clip for Rigid Aluminum Pipe

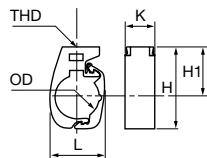

PART NO.	OD (IN)	OD (MM)	THD SIZE (IN)	L (IN)
6697 17 01	1/2	16.5	1/4	1 3/16
6697 25 01	1	25	1/4	1 1/2
6697 40 01	1 1/2	40	1/4	2

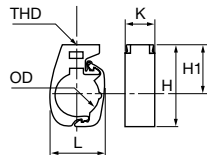

PART NO.	OD (IN)	OD (MM)	THD SIZE (IN)	L (IN)
6697 50 01	2	50	3/8	2 7/8

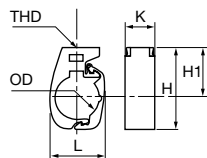

PART NO.	OD (IN)	OD (MM)	THD SIZE (IN)	L (IN)
6697 63 01	2 1/2	63	3/8	2 7/8

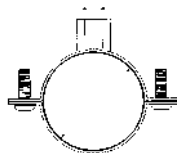

PART NO.	OD (IN)	OD (MM)	THD SIZE (IN)
ER01 L1 00	3	76	3/8
ER01 L3 00	4	101	3/8
ER01 L8 00	6	168	3/8

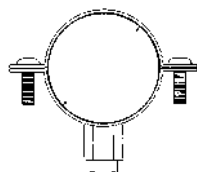

PART NO.	OD (IN)	OD (MM)	THD SIZE (IN)
EX01 L1 00	3	76	3/8
EX01 L3 00	4	101	3/8

**WARNING:** This product can expose you to chemicals including Lead and Lead Compounds which is known to the State of California to cause cancer and birth defects or other reproductive harm. For more information go to [www.P65Warnings.ca.gov](http://www.P65Warnings.ca.gov)

**Pipe Diameters: 1/2" to 2-1/2"**

**Spacer**

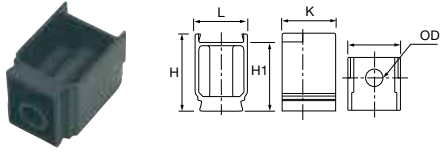

PART NO.	OD (IN)	OD (MM)	L (IN)
6697 00 03	7/16	11	1 3/16

This spacer, in association with a Transair® pipe clip, allows consistent alignment of pipes when different diameters of pipe are run concurrently in the same line.

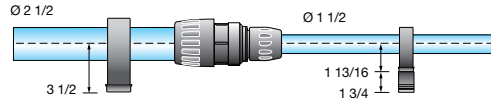

**Diameters: 1/2" to 2-1/2"**

**Threaded Rod Adapter**



PART NO.	THD SIZE (IN)	E (IN)	H (IN)
0169 00 05 00	1/4	5/8	1 3/16

The use of this adapter facilitates the suspension of Transair® with 3/8" threaded rod.

**WARNING:** This product can expose you to chemicals including Lead and Lead Compounds which is known to the State of California to cause cancer and birth defects or other reproductive harm. For more information go to [www.P65Warnings.ca.gov](http://www.P65Warnings.ca.gov)

# Hose Reels

## Product Features:

- Optimize productivity and the safety of your work area
- Prevent hose damage occurring on the workshop floor

## Specifications:

**Max. Working Pressure\*:** 6698 11 11: 250 PSI (17.2 bar)  
6698 11 12: 250 PSI (17.2 bar)

**Working Temperature:** -4° to +140° F (-20° to +60° C)

\* Dependant on the model

### Hose Length 25' to 50'

### Light Series Hose Reel

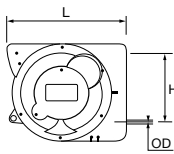

PART NO.	HOSE ID (IN)	MAX. PRESSURE (PSI)	HOSE LENGTH (FT)	L (IN)
6698 11 11	3/8	250	25	11 13/16

Hose clutch with free return. Outlet connection 1/4 male - 3/8" inlet

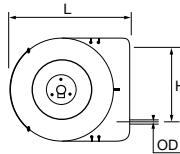

PART NO.	HOSE ID (IN)	MAX. PRESSURE (PSI)	HOSE LENGTH (FT)	L (IN)
6698 11 12	3/8	250	50	15 3/8

Hose clutch with free return. Outlet connection 1/4 male - 3/8" inlet



**WARNING:** This product can expose you to chemicals including Lead and Lead Compounds which is known to the State of California to cause cancer and birth defects or other reproductive harm. For more information go to [www.P65Warnings.ca.gov](http://www.P65Warnings.ca.gov)





# Composite Automatic Safety Couplers

## Product Features:

- For quick and repetitive connection and disconnection
- 100% safety – ISO 4414 and European EN 983 compliant
- Very high flow, extremely low pressure loss
- Lightweight and robust
- Improved hand grip
- Fast vent time
- Male thread with integral seal
- Suitable fluids: compressed air, argon, nitrogen (please consult us for other fluids)

## Specifications:

**Max. Working Pressure:** 232 PSI (15.9 bar)  
**Working Temperature:** 4° to +140° F (-20° to +60° C)

ISO B  
1/4"  
Safety



### Male NPT

PART NO.	THD SIZE (IN)
CP05 U1N02	1/4
CP05 U1N03	3/8
CP05 U1N04	1/2



### Female NPT

PART NO.	THD SIZE (IN)
CP15 U1N02	1/4
CP15 U1N03	3/8
CP15 U1N04	1/2



### Coupler with Hosetail

PART NO.	Od (MM)
CP21 U1 06	6
CP21 U1 08	8
CP21 U1 10	10

ISO B  
3/8"  
Safety



### Male NPT

PART NO.	THD SIZE (IN)
CP05 U2N02	1/4
CP05 U2N03	3/8
CP05 U2N04	1/2



### Female NPT

PART NO.	THD SIZE (IN)
CP15 U2N02	1/4
CP15 U2N03	3/8
CP15 U2N04	1/2



### Coupler with Hosetail

PART NO.	Od (MM)
CP21 U2 08	8
CP21 U2 10	10
CP21 U2 13	13

ARO  
1/4"  
Safety



### Male NPT

PART NO.	THD SIZE (IN)
CP05 A1N02	1/4
CP05 A1N03	3/8
CP05 A1N04	1/2



### Female NPT

PART NO.	THD SIZE (IN)
CP15 A1N02	1/4
CP15 A1N03	3/8
CP15 A1N04	1/2



### Coupler with Hosetail

PART NO.	Od (MM)
CP21 A1 06	6
CP21 A1 08	8
CP21 A1 10	10

## Safety

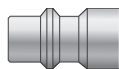
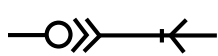

ISO B 1/4"  
ISO 6150 B  
AFNOR NF 49-053  
US.MIL.C4109  
CEJN 310  
RECTUS 23-24

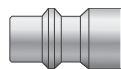

ISO B 3/8"  
ISO 6150 B  
AFNOR NF 49-053  
US.MIL.C4109  
CEJN 430  
RECTUS 30

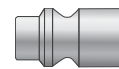

ARO 1/4"  
ARO 210  
CEJN 300  
ORION 44510  
PARKER 50  
RECTUS 14-22

## Flow Curve - Pressure Loss

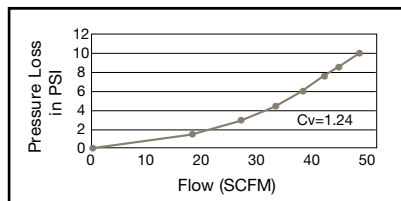

**WARNING:** This product can expose you to chemicals including Lead and Lead Compounds which is known to the State of California to cause cancer and birth defects or other reproductive harm. For more information go to [www.P65Warnings.ca.gov](http://www.P65Warnings.ca.gov)



## How to Use

Transair® composite automatic couplers comply with worldwide ISO 4414 and European EN 983 safety standards. Disconnection is by a double twist of the sleeve.

**1st rotation**  
in direction  
of the arrow:  
pressure rapidly vented  
out, plug side.



**2nd rotation**  
in direction  
of the arrow:  
safe disconnection of  
body and plug.



ISO B  
1/4"



### Male Plug NPT

PART NO.	THD SIZE (IN)
9084 23 14	1/4
9084 23 18	3/8



### Female Plug NPT

PART NO.	THD SIZE (IN)
9083 23 14	1/4
9083 23 18	3/8



### Plug with Hosetail

PART NO.	ID (IN)
9085 23 56	1/4
9085 23 08	5/16
9085 23 60	3/8

ISO B  
3/8"



### Male Plug NPT

PART NO.	THD SIZE (IN)
9084 30 14	1/4
9084 30 18	3/8



### Female Plug NPT

PART NO.	THD SIZE (IN)
9083 30 14	1/4
9083 30 18	3/8



### Plug with Hosetail

PART NO.	ID (IN)
9085 30 08	5/16
9085 30 60	3/8
9085 30 62	1/2

ARO  
1/4"



### Male Plug NPT

PART NO.	THD SIZE (IN)
9084 22 14	1/4
9084 22 18	3/8



### Female Plug NPT

PART NO.	THD SIZE (IN)
9083 22 14	1/4
9083 22 18	3/8

## Flow Curve - Pressure Loss

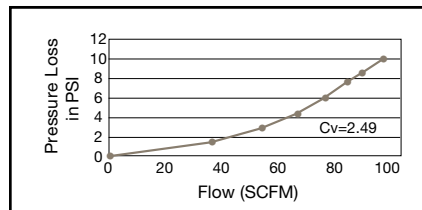

**WARNING:** This product can expose you to chemicals including Lead and Lead Compounds which is known to the State of California to cause cancer and birth defects or other reproductive harm. For more information go to [www.P65Warnings.ca.gov](http://www.P65Warnings.ca.gov)







# Transair® Installation Guide

Essential Instructions

Aluminum Pipe Section

Pipe to Pipe Connectors

Quick Assembly Brackets

Transair® Flexible Hose

Fixture Accessories

transair®



# Essential Instructions

## Features

- Compressor outlets (absorption of vibration)
- To bypass obstacles and join different levels
- Expansion loops
- Resistant to mineral and synthetic compressor oils
- Fire resistant (conforms to ISO 8030 standard for compressed air flexible hose and to EN 12.115 standard for vacuum flexible hose)

## General

Prior to the installation of a Transair® compressed air distribution system, the installer should ensure that the installation area complies with any regulations applicable to areas exposed to explosive hazards (in particular the effect of static electricity in a silo area). Transair® should be installed downstream of the compressed air receiver, or after the dryer. Flexible Transair® hose can be installed at the start of the system in order to eliminate any sources of vibration and to facilitate maintenance operations. When maintaining or modifying a Transair® system, the relevant section should be vented prior to the commencement of any work. Installers should use only Transair® components and accessories, in particular Transair® pipe clips and fixture clamps. The technical properties of the Transair® components, as described in the Transair® catalog, must be respected.

## Pressurizing the system

Once the Transair® installation has been installed and prior to pressurizing, the installer should complete all tests, inspections and compliance checks as stated in any contract and according to sound engineering practice and current local regulations.

## Transair® pipe and hoses

Transair® pipe should be protected from mechanical impact, particularly if exposed to collision with fork-lift trucks or when sited in an environment with moving overhead loads. Similarly, rotation of the pipe and pipe supports should be avoided. Transair® pipe must not be welded. Flexible Transair® hoses should be used in accordance with the recommendations of the installation guidelines.

Note: In certain situations, Transair® aluminum pipe may be formed with a bend - please contact us for further information.

## Specifications:

**Max. working pressure for flexible hose used for compressed air\*:** 188 PSI from -4° to +140° F (12.9 bar from -20° to +60° C)  
232 PSI from -4° to +115° F (15.9 bar from -20° to +46.1° C)

**Vacuum:** 98.7% (29.6" Hg)

**Working Temperature** -4° to +140° F (-20° to +60° C)

\* Please consult us for higher temperature requirements

## Expansion / contraction

Expansion and contraction of the system should be calculated prior to installation. The system designer and installer should calculate the elongation or retraction of each Transair® line according to the recommendations in this installation guide.

## Component assembly

Transair® components are provided with assembly instructions for their correct use - simply follow the methods and recommendations stated in this document.

Transair® installations - situations to avoid

- Installation within a solid mass (concrete, foam, etc.)
- The hanging of any external equipment to Transair® pipe
- The use of Transair® for grounding, or as a support for electrical equipment
- Exposure to chemicals that are incompatible with Transair® components (please contact us for further details)

## Sound engineering practice for the optimization of an air pipe system

- When installing a Transair® system, the work should be performed in accordance with good engineering practice.
- Bends and bypasses represent sources of pressure drop. To avoid excessive pressure loss, use modular consoles to offset the network and to bypass obstacles. Keep in-line pipe diameter reductions to a minimum.
- Maintain a consistent level of good quality air by use of adequate filtration at the compressor outlet.
- The diameter of the pipe will influence pressure drop and the operation of point-of-use equipment. Select the diameter according to the required flow rate and acceptable pressure drop at the point of use.
- Position drops should be as close as possible to the point of use.

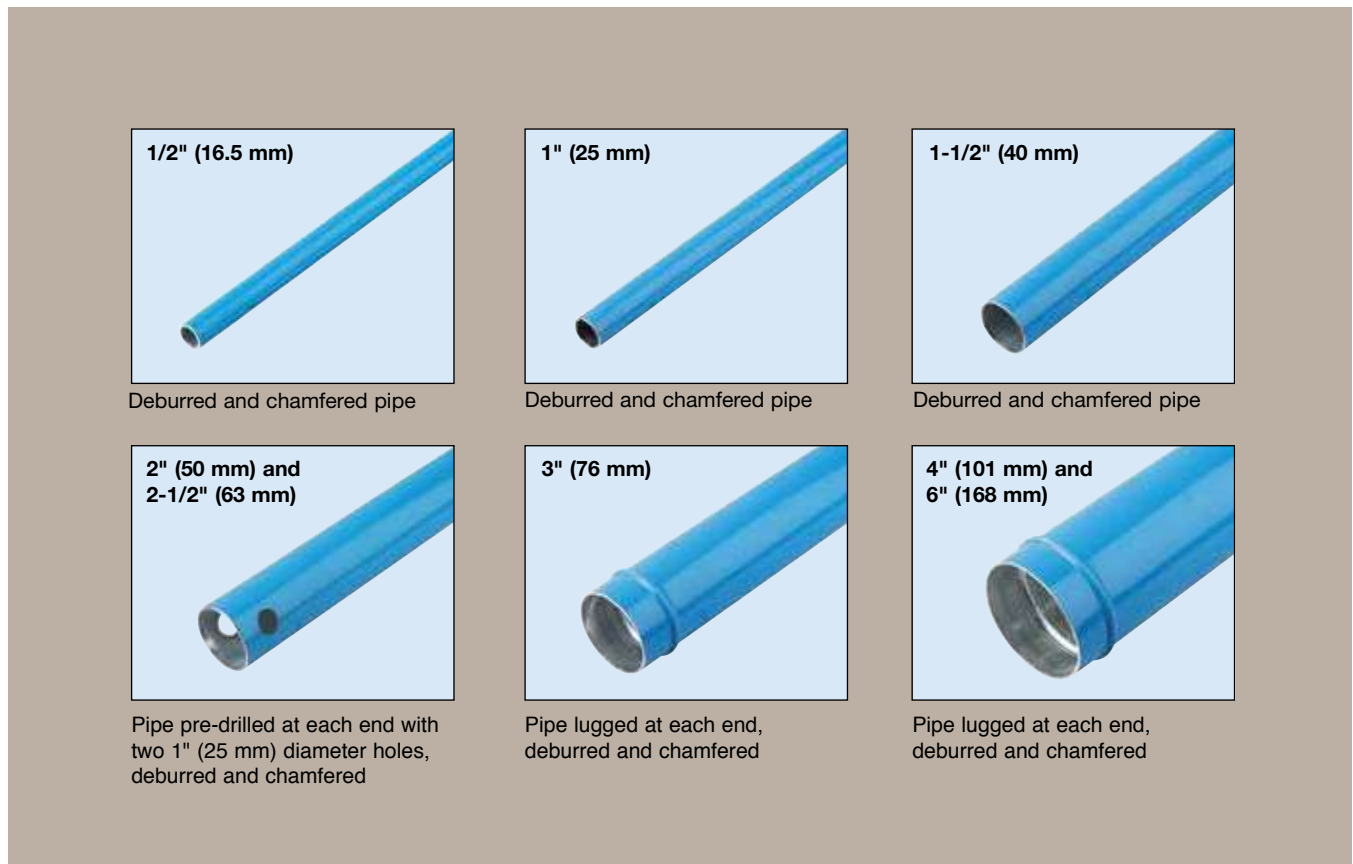

**Presentation**

Transair® aluminum pipe is supplied ready for use. No particular preparation (cutting, deburring, chamfering, etc.) is required.

Thanks to the rigidity of Transair® aluminum pipe, temperature-related expansion / contraction is reduced to a minimum. The Transair® system retains its straightness, and hence its performance, over time (reduction of pressure drop caused by surface friction).

Transair® aluminum pipe is calibrated and fits perfectly with all Transair® components. Each connection is automatically secured and the seal is optimized, which minimizes corrosion to the internal surface.

Transair® aluminum pipe has a protective powder coating (Qualicoat certified) and is thus protected from external corrosion. Its color allows the system to be immediately identified and gives a clean and aesthetic overall appearance.

Standard colors available:

- Blue (RAL 5012/bs1710)
- Gray (RAL 7001)
- Green (RAL 6029)

(Please contact us for other colors)

Transair® aluminum pipe is available in seven diameters from 1/2" to 6".

**Applications**

Transair® 1/2" to 6" aluminum pipe has been specially designed for compressed air, vacuum and inert gases (argon, nitrogen) – please contact us for other fluids.

**Marking**

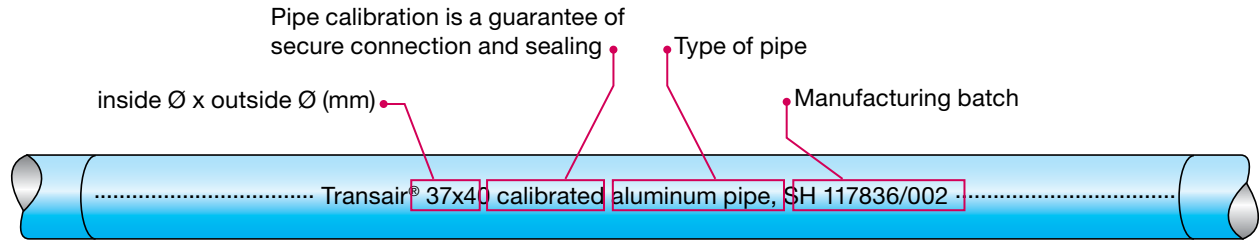

The transported fluid can be instantly identified by the color of the pipe

- ex: Blue pipe      → compressed air system
- ex: Gray pipe     → vacuum system
- ex: Green pipe    → inert gas system

**Connection indicator**

Only on 1/2" to 1 1/2" aluminum pipe

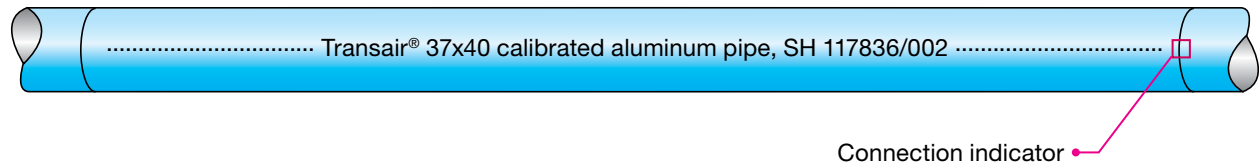

**Drilling locator: mark lines for correct drilling**

Only on 1/2" to 2 1/2" aluminum pipe

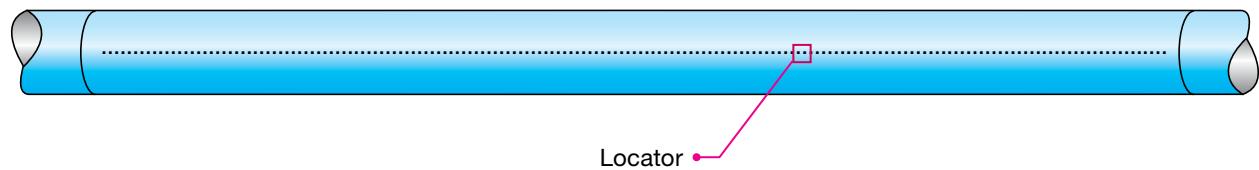

Drilling locators are used to correctly position Transair® brackets onto the pipe. There are two locators on each pipe. The second locator is used to position a second bracket perpendicular to a first bracket.



# Aluminum Pipe Section

1/2" to 1-1/2"

## Tools

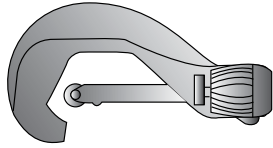

Pipe cutter for aluminum pipe  
ref. 6698 03 01



Chamfer tool for aluminum pipe  
ref. 6698 04 01

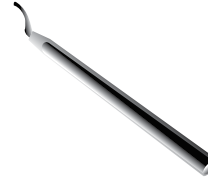

Deburring tool for aluminum pipe  
ref. 6698 04 02



Marking tool for aluminum pipe  
ref. 6698 04 03

## Procedure

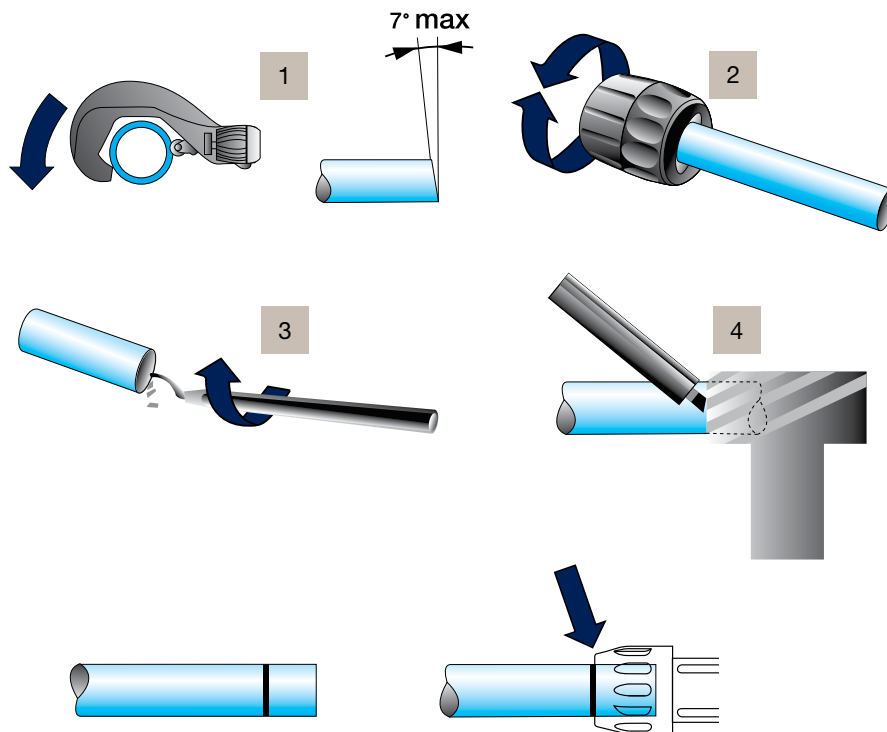

1. Cutting the pipe:  
place the pipe in the pipe cutter  
position the blade onto the pipe  
rotate the pipe cutter around the pipe  
while gently tightening the wheel
2. Carefully chamfer the outer edges
3. Deburr the inner end of the pipe
4. Trace the connection indicator  
using the marking tool

The insertion lengths for 1/2", 1" and 1 1/2" connectors are 25 mm, 27 mm and 45 mm respectively, with the exception of the end cap (6625), for which the insertion lengths are of 39 mm, 42 mm and 64 mm respectively.

## 2" to 2-1/2"

### Tools

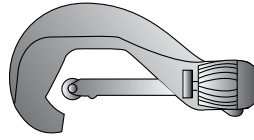

Pipe cutter for aluminum pipe ref. 6698 03 01



Chamfer ref. 6698 04 01



Deburring tool for aluminum pipe ref. 6698 04 02

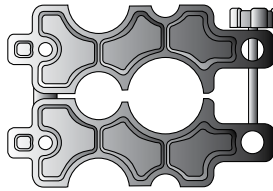

Drilling jig for aluminum pipe ref. 6698 01 02

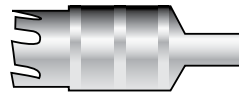

Drilling tool for aluminum pipe ref. 6698 02 01

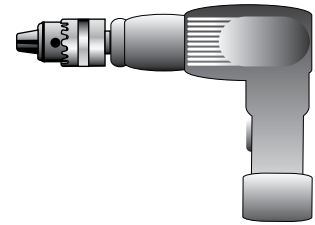

Drill

### Procedure

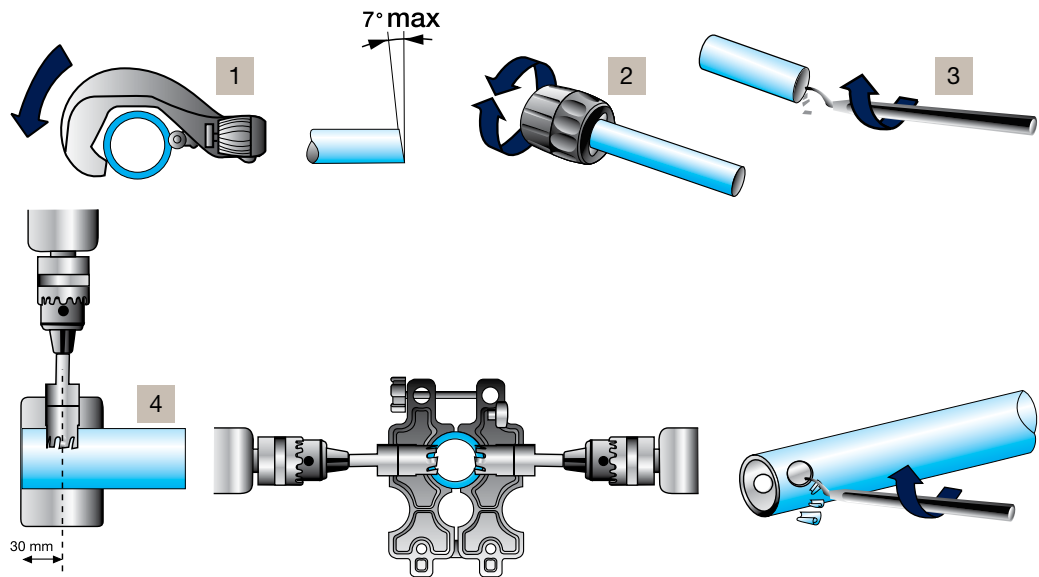

1. Cutting the pipe:  
place the pipe in the pipe cutter position the blade on the pipe rotate the pipe cutter around the pipe while gently tightening the wheel
2. Carefully chamfer the outer edges
3. Deburr the inner end of the pipe
4. Drill the two clamp holes using the drilling jig (6698 01 03) and the 1" drilling tool (6698 02 01). Loosen the jig, release the pipe, then deburr both holes. Ensure that all outer and inner surfaces are smooth and clear of burrs and potential sharp edges.

### 3" to 6"

#### Tools

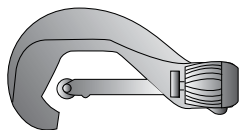

Pipe cutter for aluminum pipe ref. 6698 03 01 (3") or EW08 00 03 (4" - 6")



Deburring tool ref. 6698 04 02



Portable tool kit ref. EW01 00 02



Pipe forming jaw set ref. EW02 L1 00 (3") or EW02 L3 00 (4") or EW02 L8 00 (6")

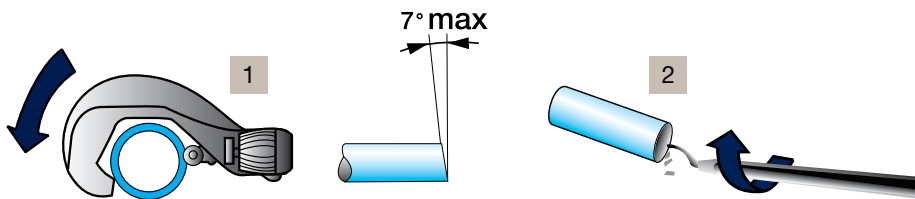

**1. Cutting the pipe:**  
place the pipe in the pipe cutter - position the blade on the pipe - rotate the pipe cutter around the pipe while gently tightening the wheel

**2. Carefully deburr the outer and inner edges of the pipe**

#### Procedure



Open the retaining pin at the front of the machine by pressing the jaw release button



Place the jaws in the housing



Lock in position by closing the retaining pin

**3. Creating the lugs for 3", 4" or 6" cut pipe**

**Procedure**

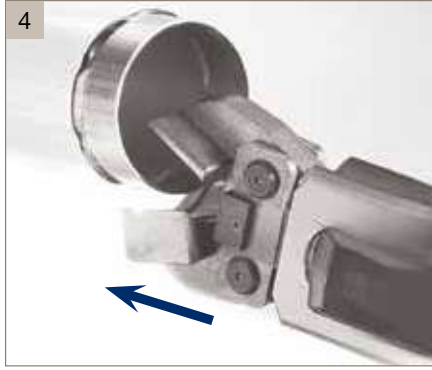

Manually open the jaws of the clamp and insert the aluminum pipe into the clamp as far as it will go

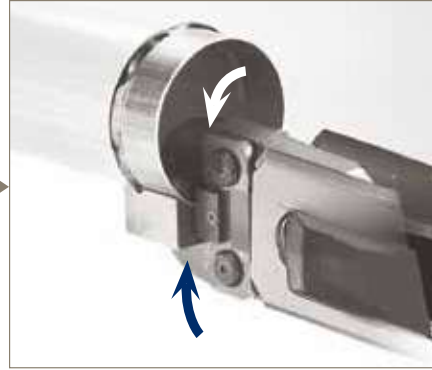

Release the jaws. Press the trigger and crimp the tube until a 'snap' sound is heard



Re-open the two jaws to remove the pipe and rotate the pipe slightly

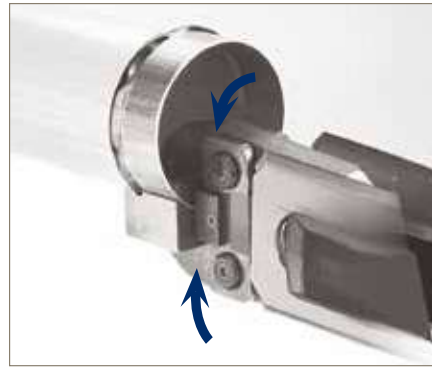

Renew the operation until the required minimum number of lugs for each diameter is achieved

	Ø 3"	Ø 4"	Ø 6"
Minimum. Number of Lugs	5	6	10

Important: Do not overlap the lugs!

# Pipe to Pipe Connectors

1/2"  
to  
1-1/2"



## Instant connection by means of a gripping ring

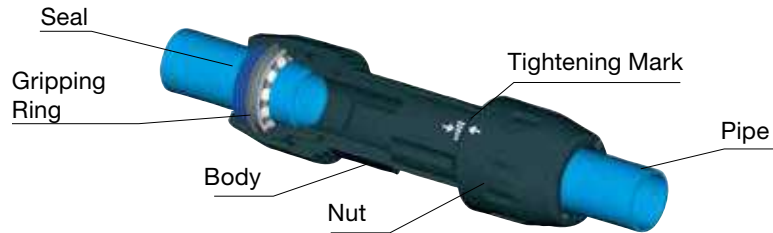

The 1/2" to 1 1/2" connectors instantly connect to Transair® aluminum pipe. Simply insert the pipe into the connector up to the connector insertion mark. The internal gripping ring is then automatically secured and the connection is complete.

2"  
2-1/2"



## Snap ring quick-fit connection



The 2" and 2 1/2" connectors are quickly secured to Transair® aluminum pipe by means of a snap ring, which makes the connector fully integrated with the pipe. Connection is achieved by simply tightening the nut.

3"  
to  
6"



## Clamp quick-fit connection

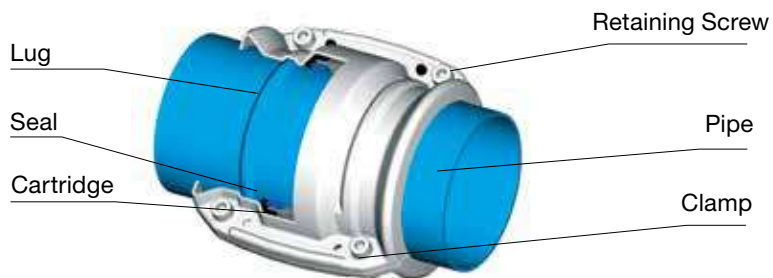

The 3" to 6" clamps secure instantly to Transair® aluminum pipe. Simply position the formed pipe within the Transair® cartridge, which acts as a seal.

Close the Transair® clamp to secure the connection and finally tighten the four retaining screws.

### Pre-assembled tightening indicators for 1/2", 1" and 1-1/2" connectors

There are important visual markings on the bodies and nuts of Transair® 1/2", 1" and 1 1/2" connectors. These are represented by solid and empty arrows and indicate the optimum torque. When assembling Transair® connectors, the nuts are tightened to a pre-defined torque on the body of the connector. This torque guarantees the seal and safety of each connection.

Before using 1/2", 1" or 1 1/2" connectors, ensure that the arrow marks are correctly aligned with each other.

There is no need to loosen the nuts prior to joining 1/2", 1" and 1 1/2" connectors to Transair® aluminum pipe.

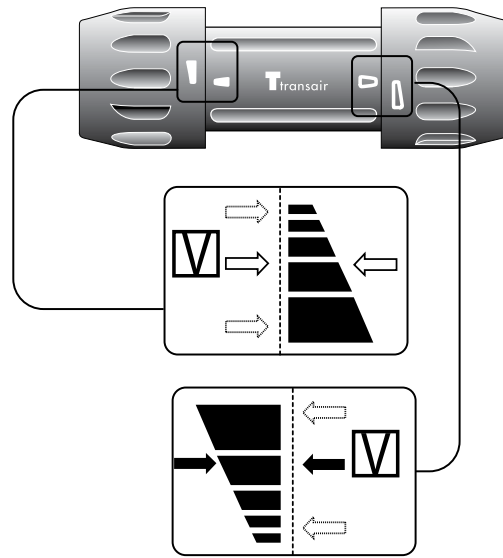

1/2"  
to  
1-1/2"

#### Connection

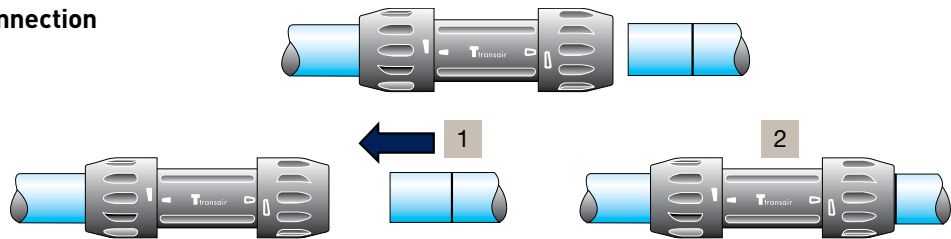

#### Disconnection

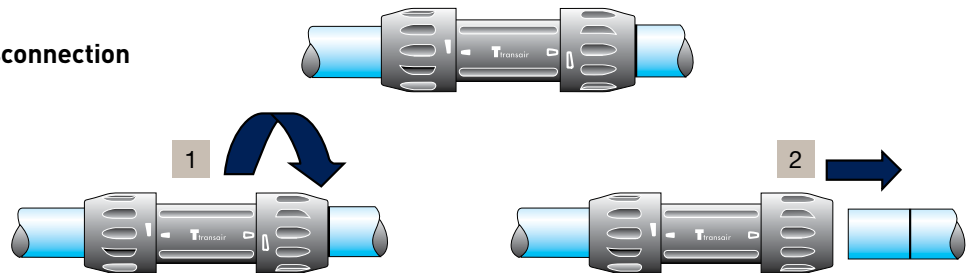

Lateral dismantling: see page 70 of this catalog.

Simply insert the pipe into the connector up to the connection mark. To disconnect, unscrew the nut by one half turn and remove the pipe.

The insertion length is greater for end caps than for other Transair® connectors. The connection mark should be applied to the pipe by means of a marker and tape measure, using the following values:

- 1 1/2": 16.5 mm
- 1 3/4": 25 mm
- 2 1/2": 40 mm

Note – when using end caps (ref. 6625)

2"

Connection

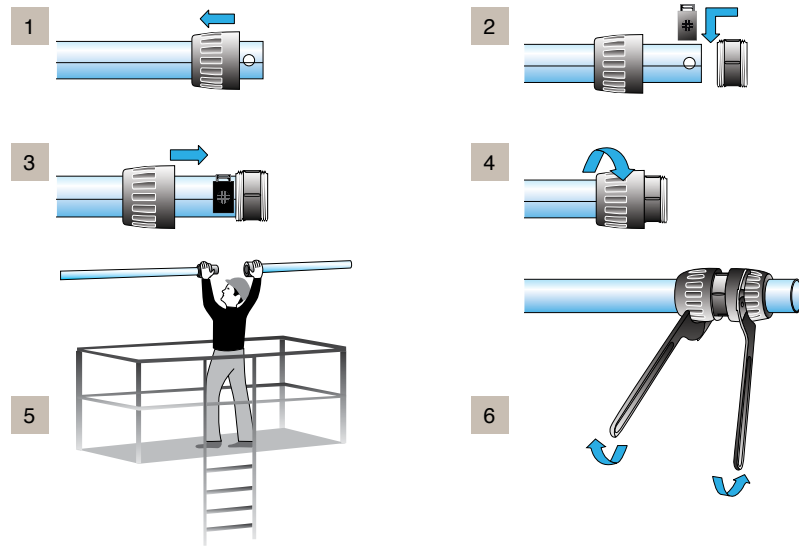

Disconnection

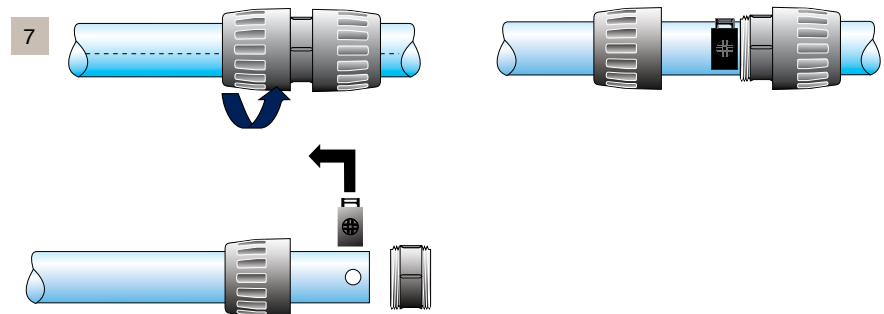

Lateral dismantling: see page 70 of this catalog.

1. Unscrew one of the connector nuts and fit over the pipe
2. Position the double clamp ring in the appropriate housings (two holes at the end of the pipe)
3. Bring the nut towards the body, which were previously positioned at the end of the pipe, until it stops against the double clamp
4. Tighten the nut by hand
5. Bring the two pipes together
6. Complete the assembly by 1/2 rotation with Transair® tightening spanners (ref. 6698 05 03)
7. To disconnect, perform the same operations in reverse order

## Connection / Disconnection

3"  
to  
6"

### Connection

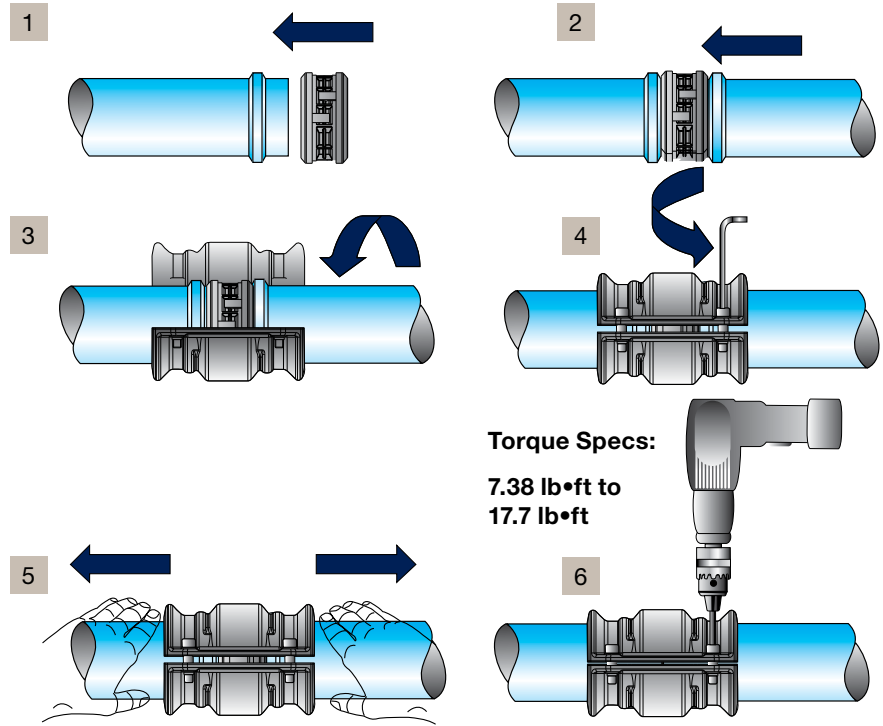

For effective clamp sealing, screw tightening should be performed on alternate sides of the clamp as shown below:

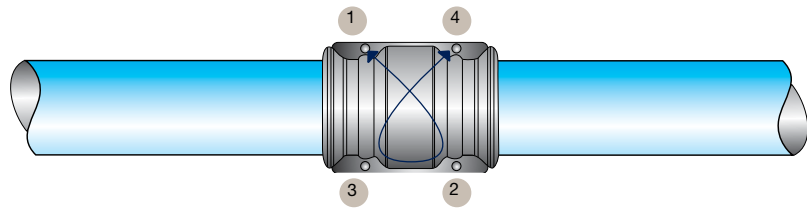

To disconnect, perform the same operations in reverse order.



## Practical examples — Various 3" and 4" configurations

Changing direction with a 90° elbow

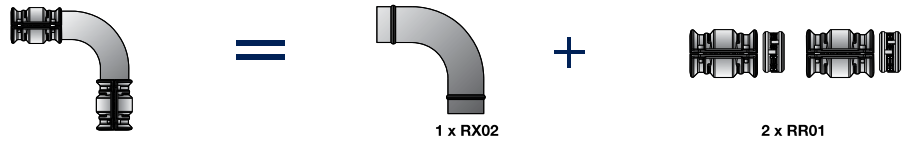

Changing direction with a tee

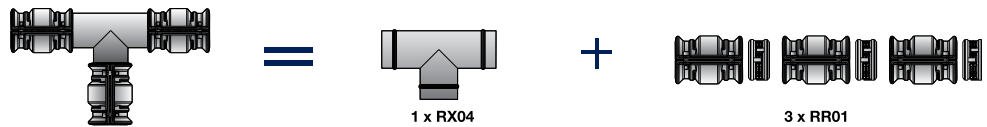

Connecting an end cap

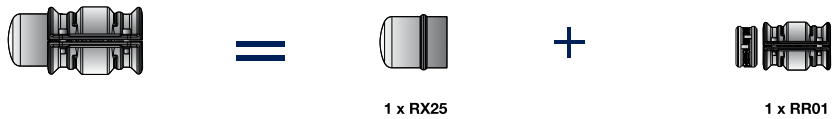

Connecting a circular flange and a connector

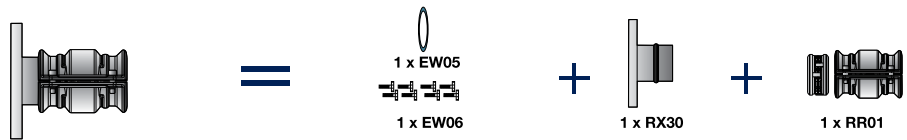

Reduction from 4" to 3"



Connecting a butterfly valve

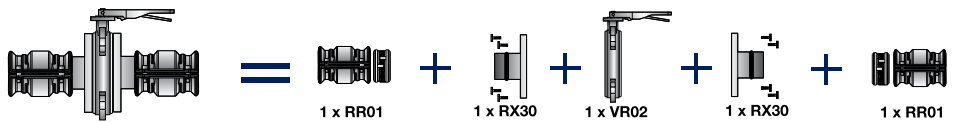

Connecting a flexible hose and a circular flange

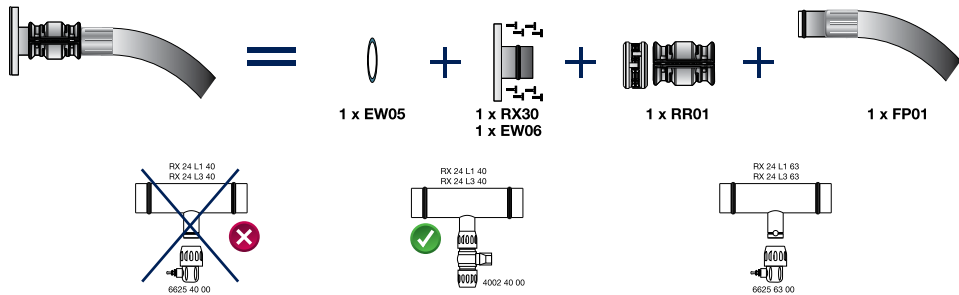

## Practical Examples

Connecting a Transair® 3" to 4" system to a Transair® 2 1/2", 2", 1 1/2", 1" or 1/2" system

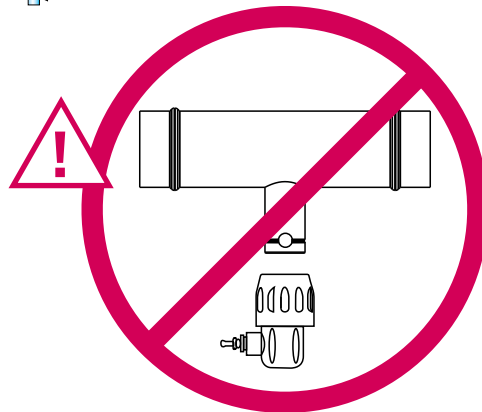
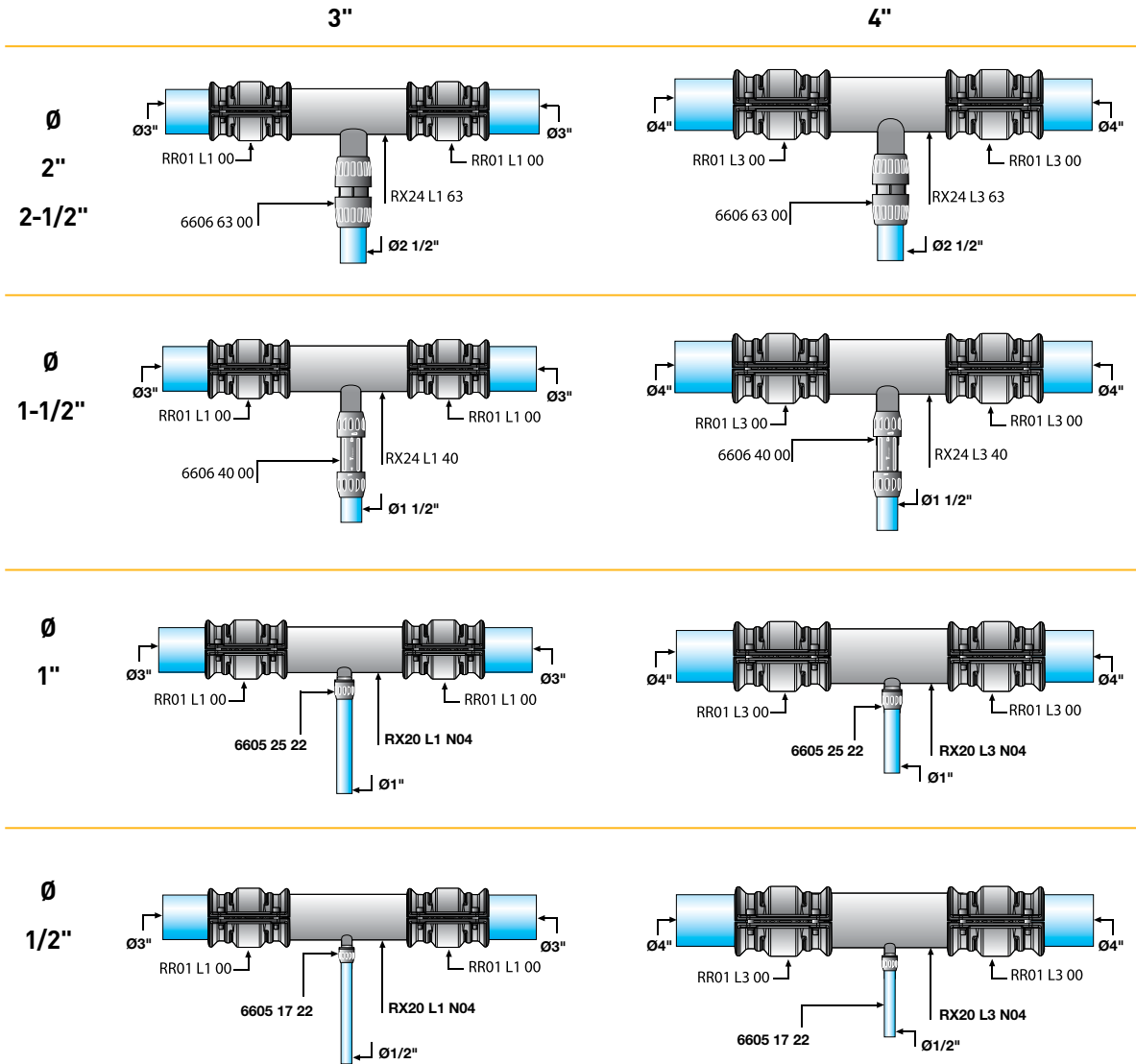

### Reducing Tee

RX24 L1 40  
RX24 L3 40

6625 40 00

## Lateral dismantling

1/2"  
to  
1-1/2"

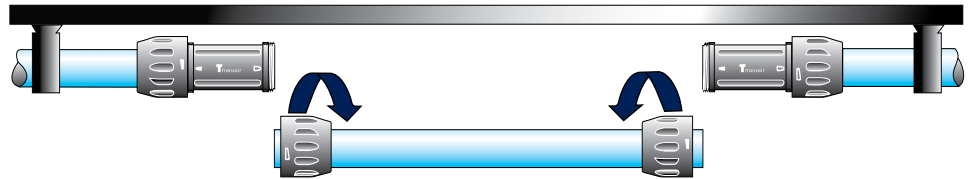

Loosen the nuts located on the side of the pipe to be removed and slide them along the pipe. Then remove the pipe.

2"  
2-1/2"

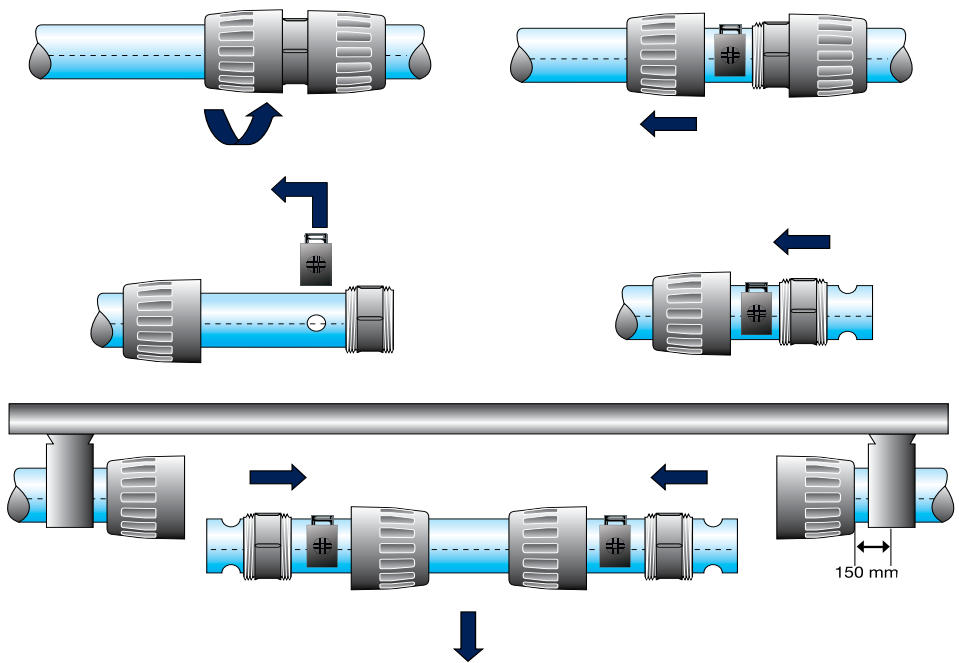

1. Loosen the connector nuts on the ends of the pipe to be removed
2. Slide them along the pipe
3. Remove the snap rings from their housings
4. Slide the clamps and the connector body along the pipe which is to be removed
5. Repeat the operation at the other end of the pipe and laterally remove the pipe, complete with the assembly components

### Transair® 1-1/2" remote shut-off valve

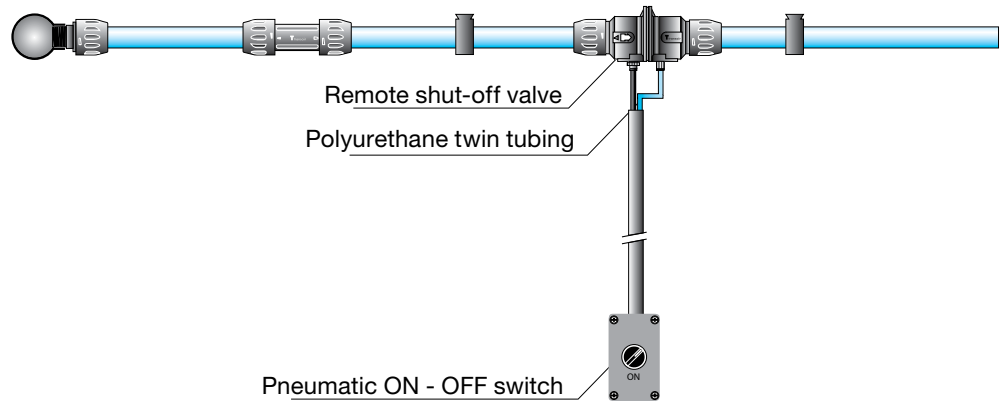

### Application

The Transair® 1 1/2" remote shut-off valve allows network supply to be rapidly and safely opened and closed either at ground level or by remote control.

The Transair® remote shut-off valve guarantees:

- Personal safety, by eliminating all hazards related to working at heights
- Servicing speed, by removing the need for special access equipment (ladder, platform etc)

### Operating principle

#### Single acting valve - normally closed.

#### For compressed air systems:

The valve control pressure can be taken upstream of the isolating valve, with no external power supply. Control is performed through the control unit connected to the valve by means of a push-in connector.

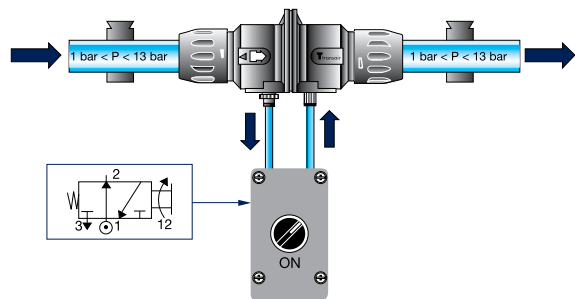

#### For vacuum systems:

A compressed air supply external to the control unit is required, and the corresponding valve port must be closed in order to prevent loss.

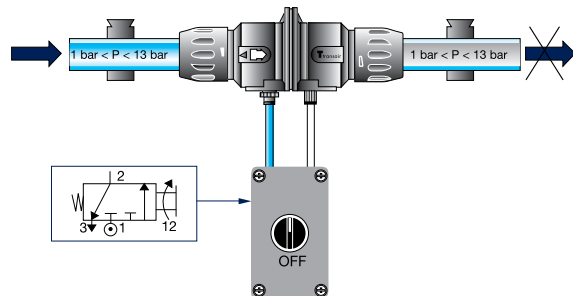

# Do's

Connection

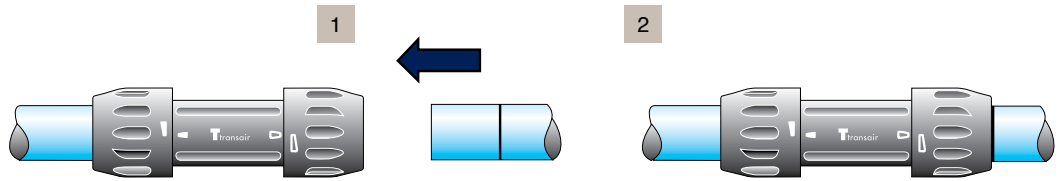

Use a pipe cutter

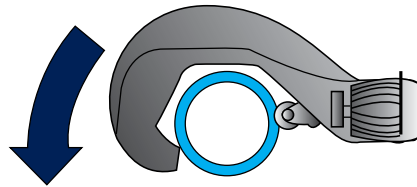

Carefully chamfer and deburr the pipe after cutting or drilling

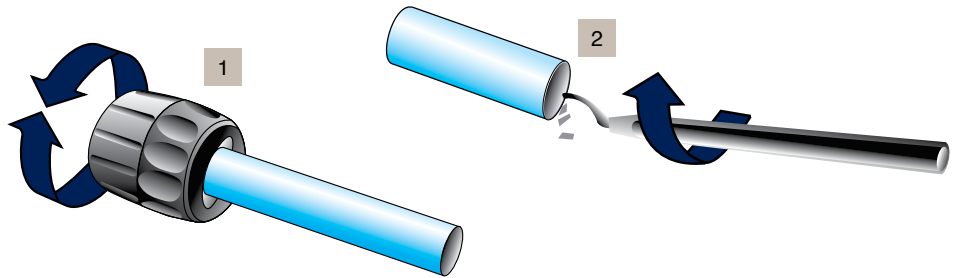

Check that the pipe is correctly positioned in the connector

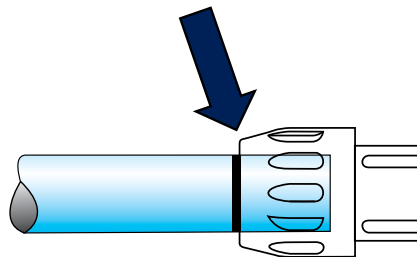

# Don'ts

Loosen the nuts during assembly

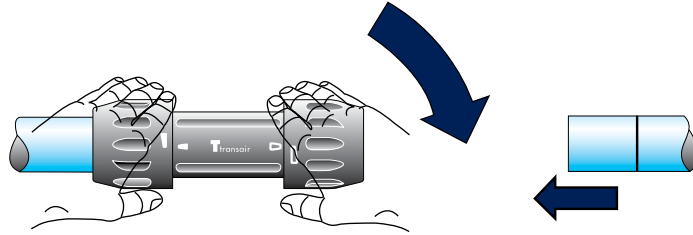

Cut the pipe with a saw

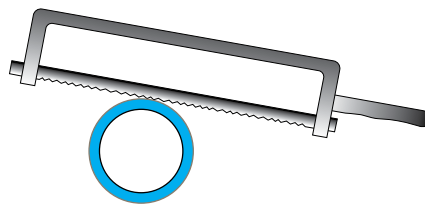

Use non-deburred pipe

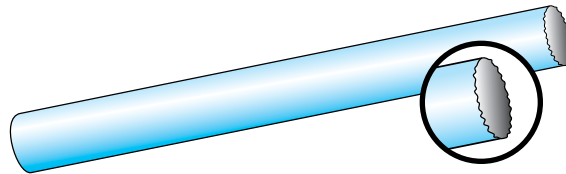

Fail to make the pipe secure

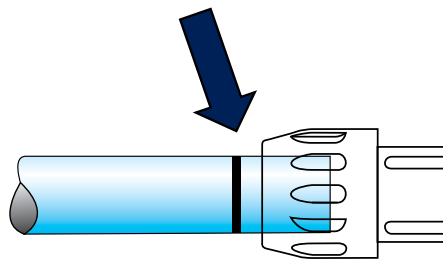

Connect 1-1/2" end cap to reducing tee

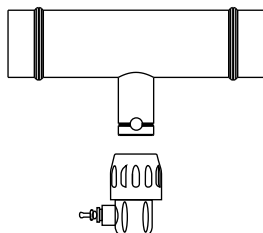

# Quick Assembly Brackets

## General

The easy addition of a new drop or bypass onto an existing length of pipe is an important consideration of any air pipe system. Transair® quick assembly brackets are designed for this very purpose, without the need to cut the pipe. A "swan neck" built into the brackets retains condensate water in the main line. Thanks to its small size, the Transair® quick assembly bracket facilitates new additions in the tightest places and can be used for connecting horizontal branch lines and vertical drops.

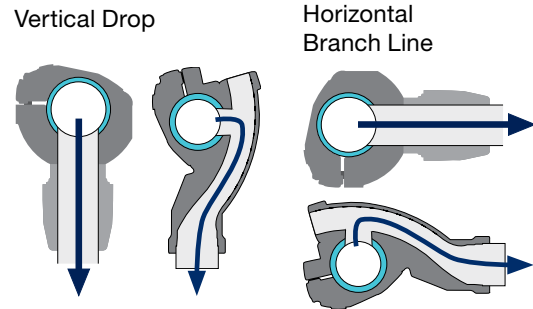

## Specific Instructions for Installing a Bracket

For the 1" and 1 1/2" Transair® quick assembly brackets, the pipe center to wall distance is equal to the bracket center to wall distance, i.e. 1 13/16". For the 2 1/2" Transair® quick assembly brackets, the pipe center to wall distance is 90mm and the 1" and 1 1/2" bracket center distance is 1 13/16". Furthermore, Transair® clips should be fitted at a distance of at least 5 15/16"

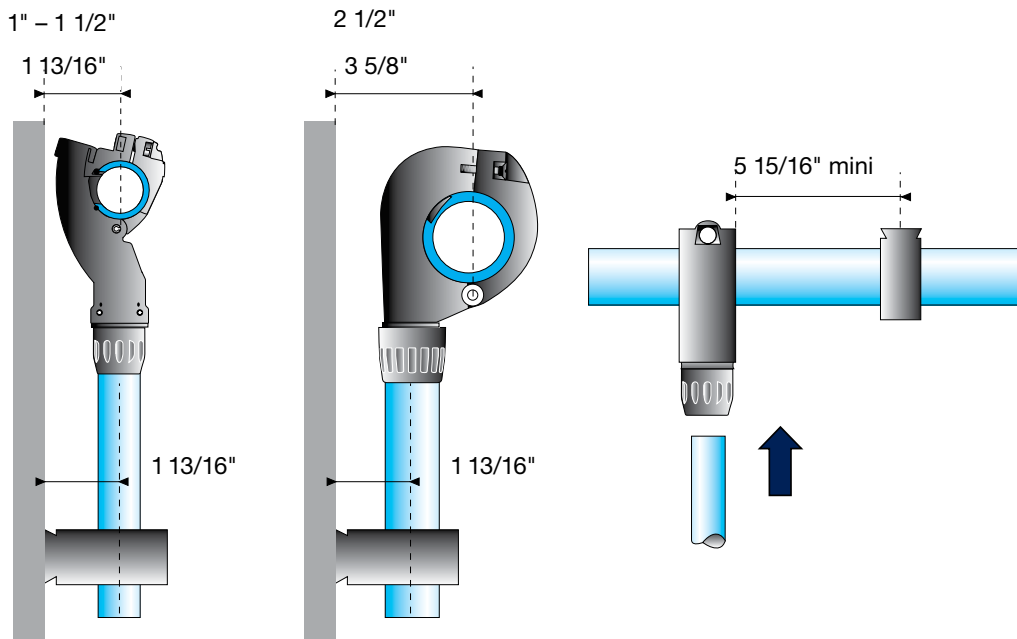

## Installing a quick assembly bracket

To 1" or  
1-1/2" pipe

### Tools required

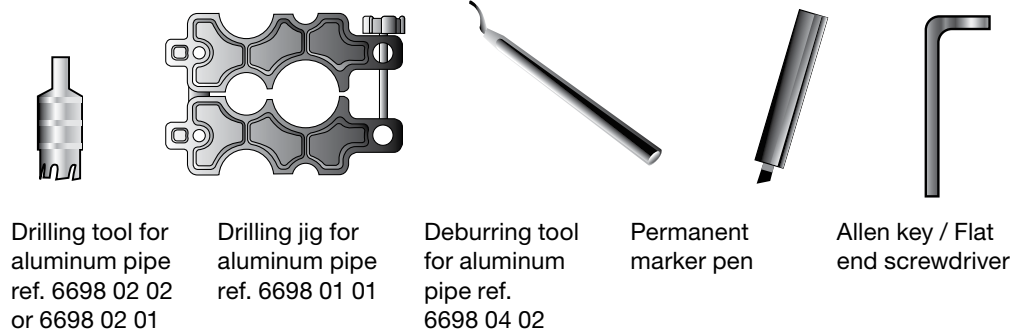

Drilling tool for aluminum pipe  
ref. 6698 02 02  
or 6698 02 01

Drilling jig for aluminum pipe  
ref. 6698 01 01

Deburring tool for aluminum  
pipe ref.  
6698 04 02

Permanent  
marker pen

Allen key / Flat  
end screwdriver

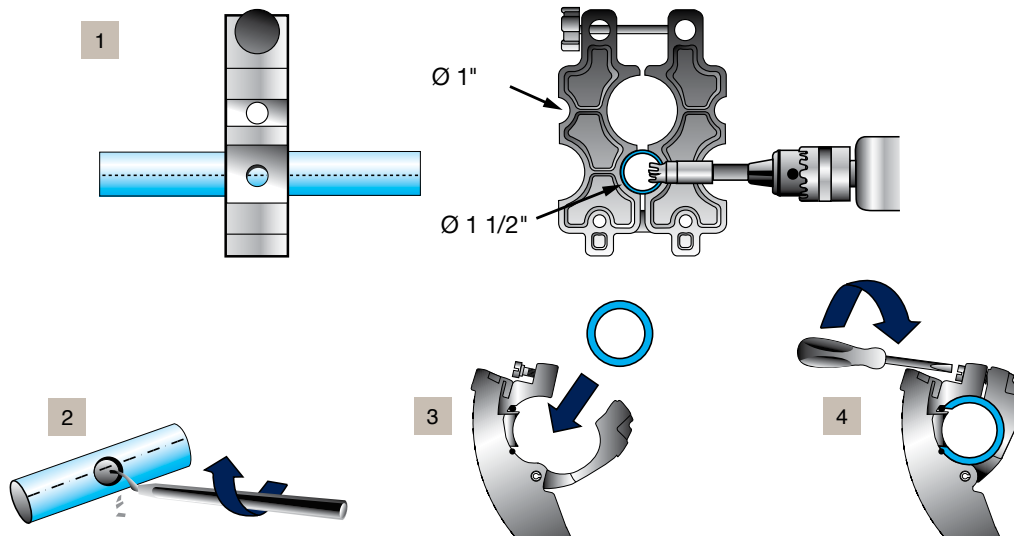

### Procedure

1. Mark the pipe at the desired position for the bracket, using the same locator mark when several take-off points need to be aligned uniformly. Place the drilling jig ref. 6698 01 01 in a vice or on the floor.  
To drill a hole in 1 1/2" pipe, loosen the retaining bolt in the jig by turning the knob and place the pipe in the jig. The locator mark on the pipe should be aligned with the appropriate guide marks on the side of the jig. Two guide lines on either side of the jig provide a rapid indication of whether the pipe is correctly positioned (the guide lines match the locator marks on the pipe). Close the jig, tighten the bolt and drill a hole using the appropriate drilling tool:
  - 1": 1/2" hole > ref. 6698 02 02 drilling tool

- 1 1/2": 1" hole > ref. 6698 02 01 drilling tool  
Recommended rotation speed: 650 rpm  
Note: drill without lubrication.
2. Release the pipe, remove any chips and deburr the circular hole. Repeat the operation for the number of brackets that you wish to fit.
  3. Position the quick assembly bracket using its location pin
  4. Tighten the screw

**Note:** The jig's second drilling guide corresponds to the minimum distance for fitting two adjacent brackets.



## Installing a bracket

On 2" and  
2-1/2" pipe

### Tools required

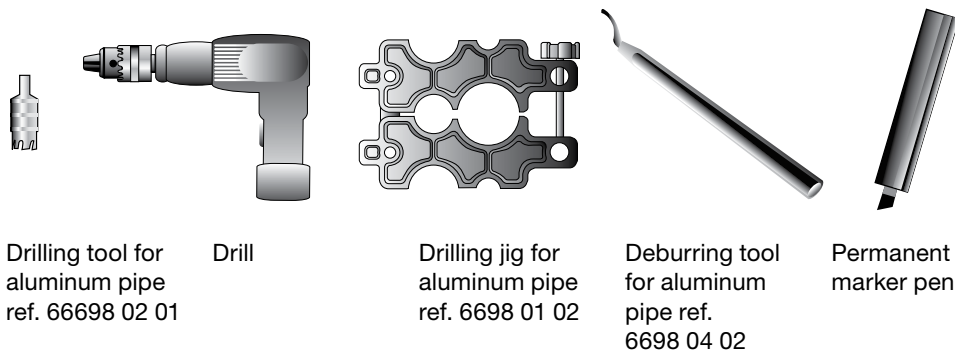

Drilling tool for  
aluminum pipe  
ref. 66698 02 01

Drill

Drilling jig for  
aluminum pipe  
ref. 6698 01 02

Deburring tool  
for aluminum  
pipe ref.  
6698 04 02

Permanent  
marker pen

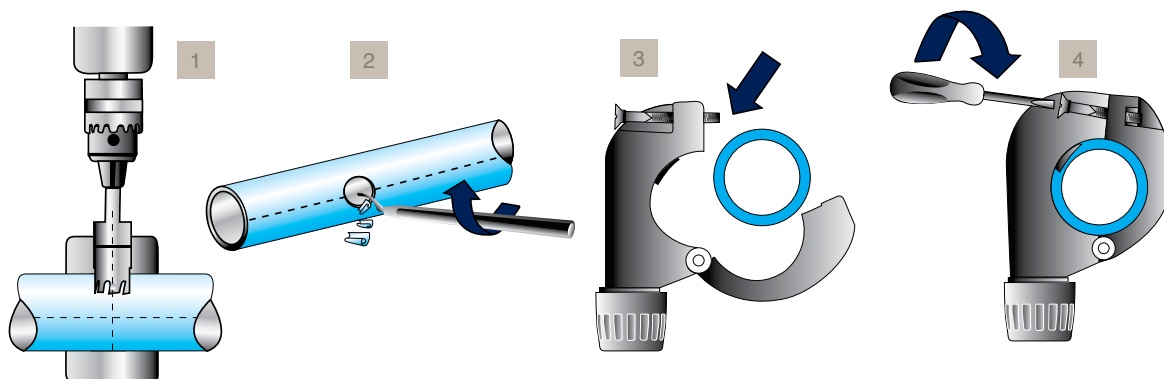

### Procedure

1. Mark the pipe at the desired position for the bracket. The mark should be placed on one of the locator marks so that multiple brackets are correctly aligned, when several take-off points are required. Place the 2 1/2" drilling jig in a vice or on the floor and place the pipe in the jig. Ensure that the line marked on the pipe is centred within the drilling guide: two marks on either side of the jig's upper side provide a rapid indication of the pipe's positioning. Tighten the locking clamp to secure the pipe and drill using the 1" drilling tool. [Recommended rotation speed: 650 rpm] Note: Drill without lubrication.
2. Loosen the locking clamp and release the pipe, remove any chips and deburr the hole. Repeat the operation for the number of brackets that you wish to fit.
3. Position the quick assembly bracket using its location hole
4. Tighten the screw

## Installing a bracket

On 3", 4"  
or 6" pipe

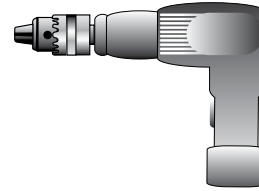

### Tools required

Drilling tool for aluminum pipe ref. EW09 00 30 (3" - 4" ) or EW09 00 51 / EW09 00 64 (6")

Deburring tool for aluminum pipe ref. 6698 04 02

Drill

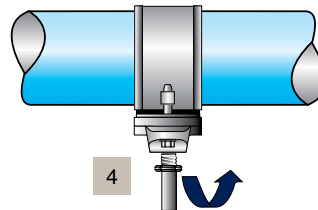
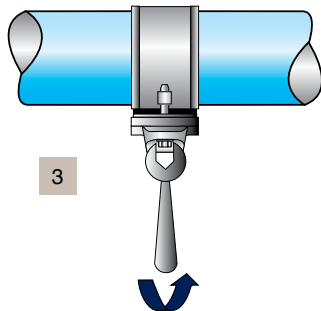
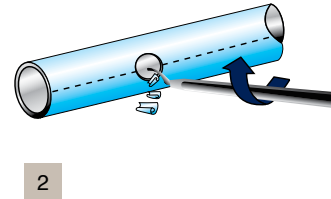
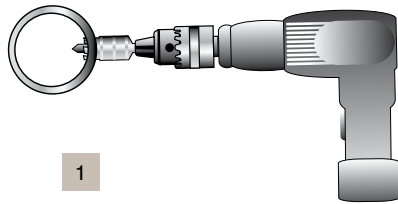

### Procedure

1. Drill the aluminum pipe at the desired position using drilling tool ref.
2. Carefully deburr the pipe
3. Position bracket ref. RR63 and fully tighten the two screws
4. Screw on male adapter

## Practical examples

Using the same locator mark

Creating vertical and horizontal take-off points

Adding a vertical bracket

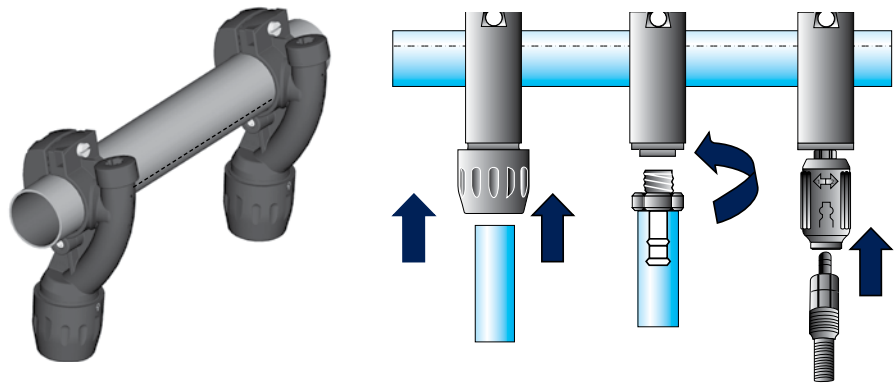

Adding an off-set bracket

Using two locator marks

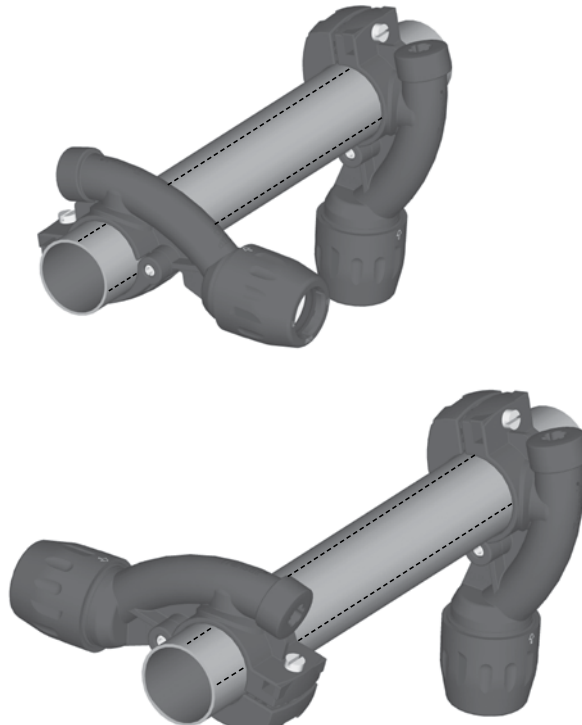

## Installing a quick assembly bracket

### Installing a bracket to a pressurized system

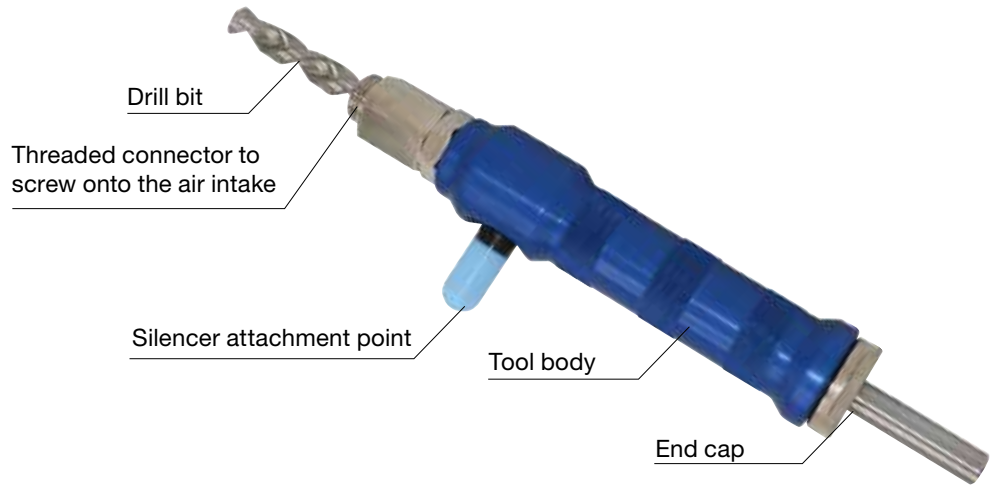

Use the under pressure drilling tool to fit a bracket to an existing pressurized system. This can be simply done with use of a standard drill.

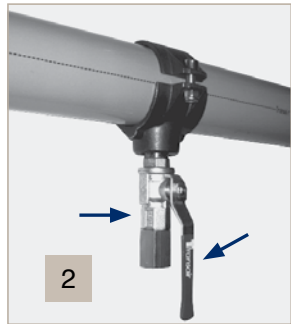

### Procedure

1. Position the pressurized system bracket and fully tighten the two screws
2. Screw the assembly onto the ball valve and ensure that the valve is open
3. Screw the drilling tool onto the ball valve until complete
4. Remove the drill and close the ball valve immediately and dismantle the drilling tool

# Transair® Flexible Hose

## General

Transair® flexible hose can be easily connected to other Transair® components and can be rapidly installed without prior preparation or cutting. Thanks to its small

## Applications

Ø (IN)	Ø (MM)	LENGTH (IN)	TRANSAIR®	R MIN (IN)
1	25	22	1001E25 00 01	4
1	25	59	1001E25 00 03	4
1	25	79	1001E25 00 04	4
1 1/2	40	45	1001E40 00 02	16
1 1/2	40	79	1001E40 00 04	16
1 1/2	40	118	1001E40 00 05	16
2	50	39	1001E50 00 09	11
2	50	78	1001E50 00 04	11
2 1/2	63	55	1001E63 00 08	12
2 1/2	63	118	1001E63 00 05	26
2 1/2	63	157	1001E63 00 06	26
3	76	59	FP01 L1 01	14
3	76	79	FP01 L1 02	14
4	101	79	FP01 L3 01	18
4	101	118	FP01 L3 03	18

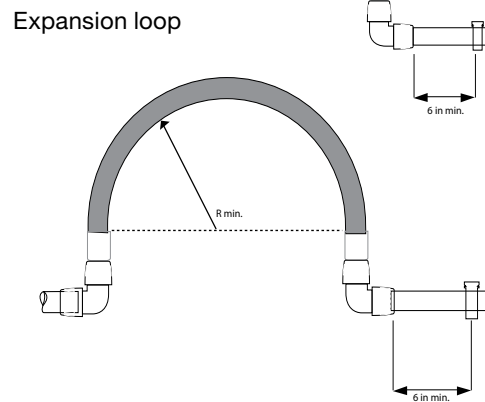
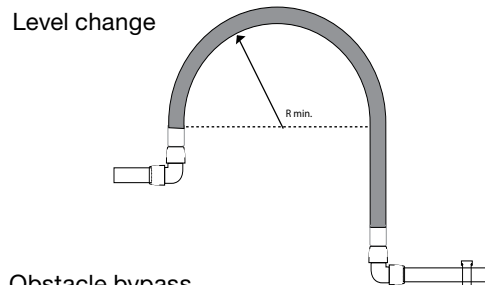

## Safety

### Anti-whiplash straps

In order to avoid the risk of whiplash accidents, Transair® recommends the use of anti-whiplash straps, which are placed on either side of the connection. If Transair® flexible tube is exposed to tear, the anti-whiplash assembly prevents it from snaking (safety device in accordance with ISO 4414 standard).

## Flexible Hose Connections

1/2" to 1-1/2"

Using a male threaded fitting

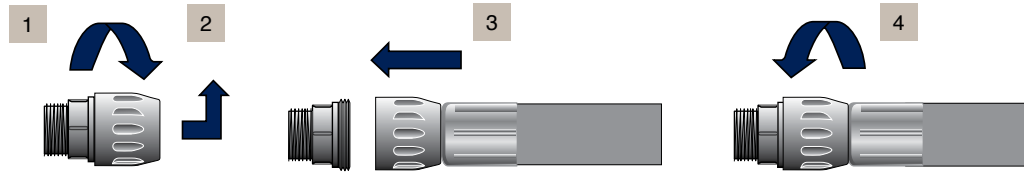

### Procedure

1. Loosen the nut on the stud fitting
2. Remove it
3. Move the swaged end of the hose onto the exposed stud thread

Using a pipe to pipe connector

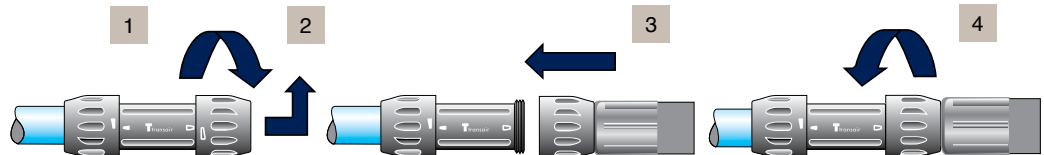

### Procedure

1. Loosen the nut on the connector
2. Remove it
3. Move the swaged end of the hose onto the connector thread

Using a 90° elbow

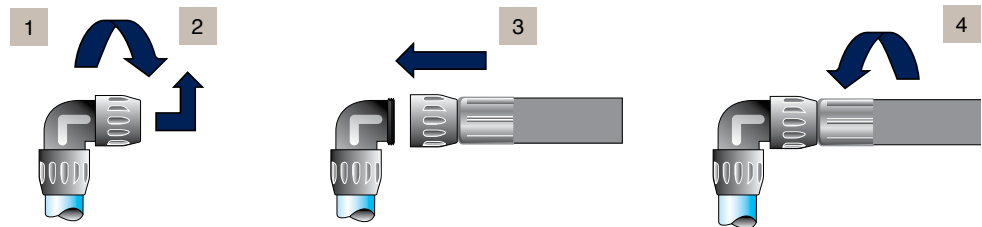

### Procedure

1. Loosen the nut on the elbow
2. Remove it
3. Move the swaged end of the hose onto the elbow thread

## Flexible Hose Connections

2"  
2-1/2"

Using a male threaded fitting

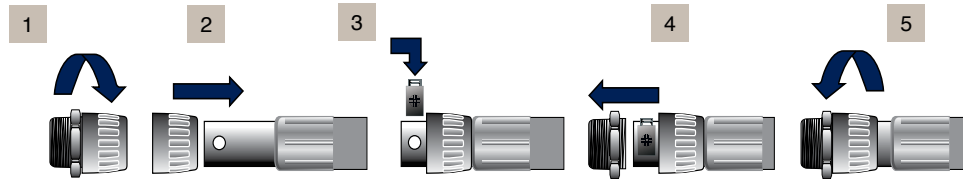

### Procedure

1. Loosen the nut on the stud fitting and remove it
2. Place the nut over the swaged end of the flexible hose
3. Place the pipe connector clamps in the housings on the hose
4. Slide the nut forward to the end of the flexible hose and assemble onto the male thread

Using a pipe to pipe connector

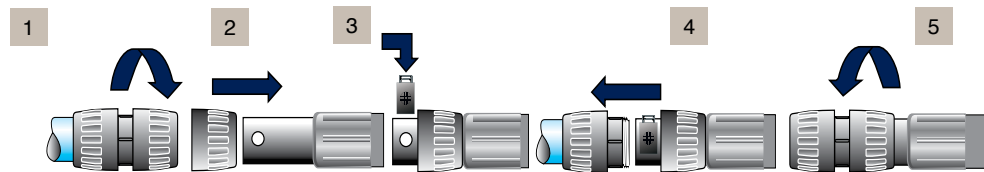

### Procedure

1. Loosen the nut on the connector and remove it
2. Fit it over the swaged end of the flexible hose
3. Place the pipe connector clamps in the housings on the hose
4. Slide the nut forward to the end of the flexible hose, until it touches the clamps

Using a 90° elbow

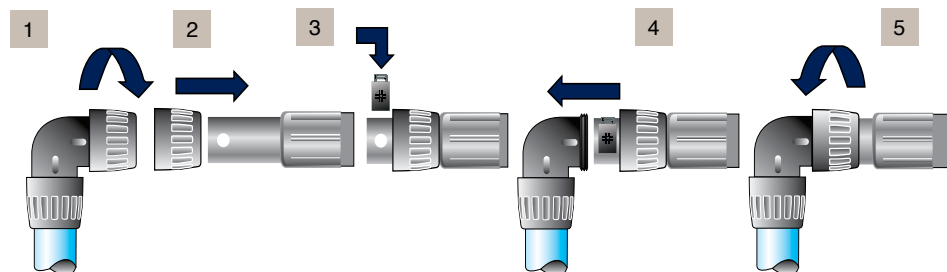

### Procedure

1. Loosen the nut on the elbow and remove it
2. Fit it over the swaged end of the flexible hose
3. Place the elbow clamps in the housings on the hose
4. Slide the nut forward to the end of the flexible hose, until it touches the clamps

### Flexible Hose Connections

3" to 6"

Using a steel clamp

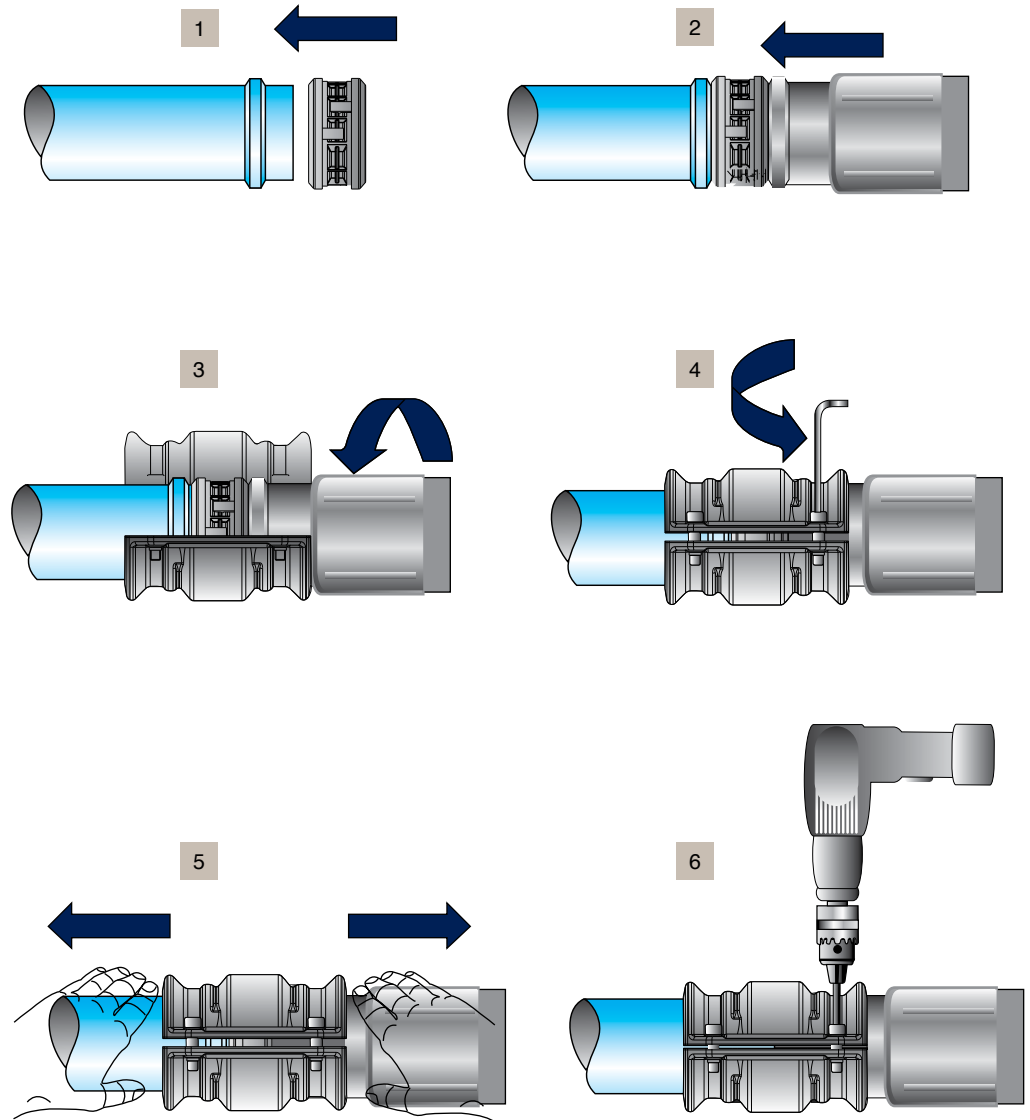







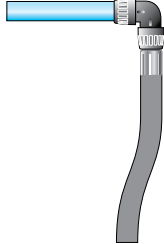



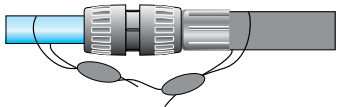

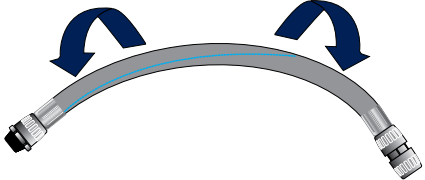

# Do's & Dont's

### Do

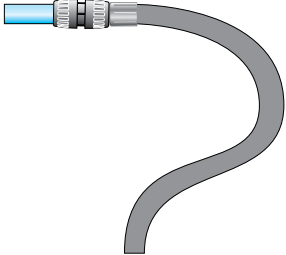
-  
-  
-  
-  
-  
-  

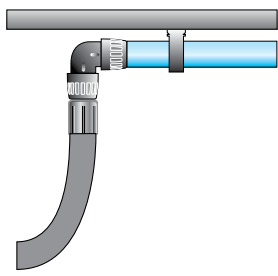
### Don't

-  
-  
-  
-  
-  
-  

# Fixture Accessories

## Transair® clip for 1/2" to 2-1/2" rigid pipe

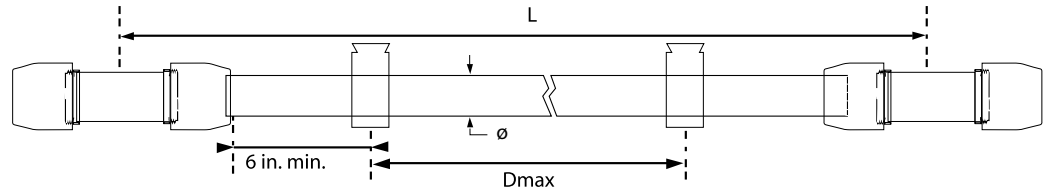

The Transair® fixing clip is the basic component for mounting pipe when installing a 1/2" – 2 1/2" Transair® aluminum system. This clip allows expansion and contraction of the pipe to occur freely.

To ensure good system stability, we recommend the use of at least two clips per pipe. Transair® aluminum pipe should only be mounted using Transair® and should not be substituted by any other type of components.

### Properties

- Transair® fixing clips for 1/2" – 1 1/2": 1/4" nuts
- Transair® fixing clips for 2" – 2 1/2" systems: 3/8" nuts

$\phi$ (IN)	$\phi$ (MM)	L (FT)	DMAX (FT)
1/2	16.5	10	8
1	25	10	8
1	25	20	10
1 1/2	40	10	8
1 1/2	40	20	10
2	50	10	10
2	50	20	10
2 1/2	63	20	10

### Procedure

1. Place the clip as required and open it using a screwdriver
2. Insert the pipe into the clip
3. Close the clip

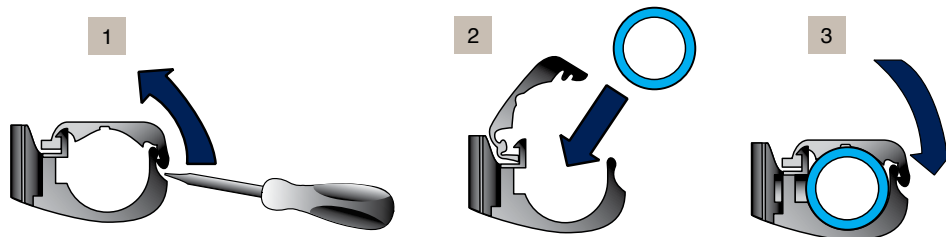

Spacer

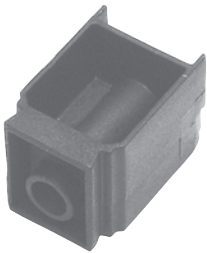

Example:

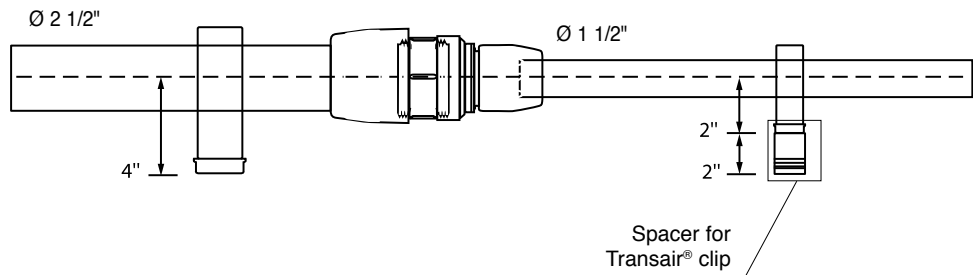

Transair® fixing clips for 3" to 6" systems

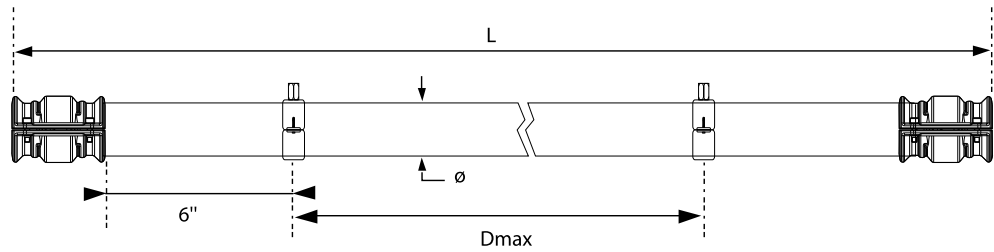

To ensure good system stability, we recommend the use of at least two fixing clips per length of pipe. Transair® fixing clips for 3" – 6" systems: 3/8" thread.

ø (IN)	ø (MM)	L (FT)	DMAX (FT)
3	76	20	16
4	101	20	16
6	168	20	16

## Supporting a Transair® system

### Directly onto a wall

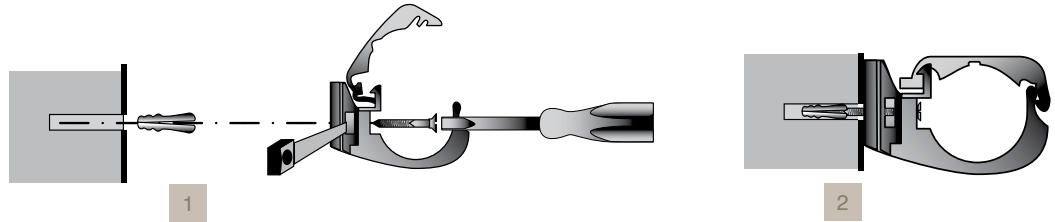

### Offset from a wall

1. Remove the nut at the base of the pipe clip using a screwdriver and insert the screw by passing it through the clip
2. Tighten the screw

### U-channel type mounting bracket

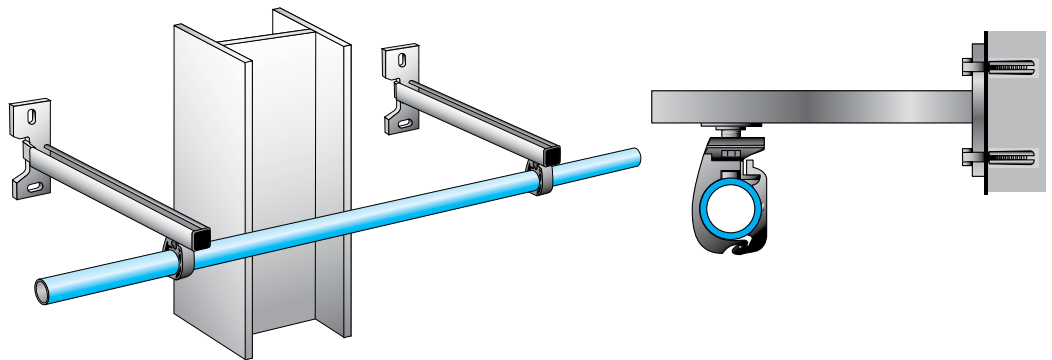

U-channel assemblies are used to offset systems and to bypass obstacles.

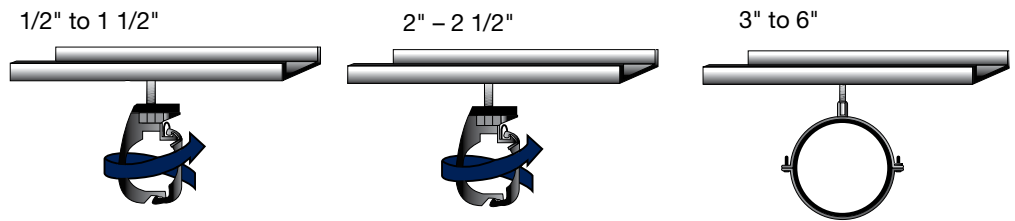

### Threaded rod adapter

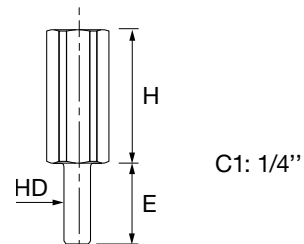

The Transair® threaded rod adaptor allows 1/2", 1" and 1 1/2" Transair® pipe clips to be easily suspended under 3/8" threaded rod.

## Supporting a Transair® system

On a metal beam

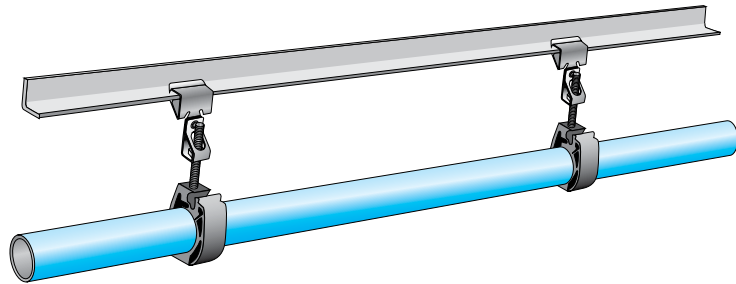

Push-on type beam clamps

Using beam clamps\*

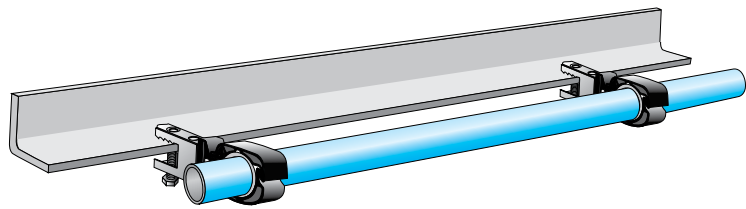

Screw type beam clamps

\*Beam clamps are not available for purchase through Parker Hannifin



### Practical Information

	Z	Z1	Z2
4002 40 00	-	4 13/16	2 1/4
4002 63 00	-	3 5/16	3 7/8
4089 17 00	-	1 1/8	1 11/16
4099 17 00	-	1 1/8	1 11/16
4099 25 00	-	1 9/16	2 3/16
4230 00 40	3 3/8	-	-
6612 25 00	1 1/8	-	-
6612 40 00	1 3/4	-	-
6612 63 00	2 3/8	-	-
6602 17 00	1 1/4	-	-
6602 25 00	1 9/16	-	-
6602 40 00	2 7/16	-	-
6602 50 00	2 1/4	-	-
6602 63 00	2 3/8	-	-
6604 17 00	-	1 5/16	1 1/4
6604 25 00	-	1 7/8	1 9/16
6604 40 00	-	2 1/4	2 1/4
6604 50 00	-	2 3/16	2 3/16
6604 63 00	-	2 7/16	2 7/16
6604 63 40	-	2 7/16	4 9/16
6606 17 00	1 5/16	-	-
6606 25 00	1 7/8	-	-
6606 40 00	2 1/4	-	-
6606 50 00	1	-	-
6606 63 00	1	-	-
6651 25 12 04	4 1/4	-	-
6651 40 12 04	5 15/16	-	-
6662 25 00	1 7/8	-	-
6662 25 17	3 1/4	-	-
6662 40 17	3 1/2	-	-
6662 40 25	3 1/4	-	-
6662 50 25	2 5/16	-	-
6662 63 25	3	-	-
6666 17 25	2	-	-
6666 25 40	2 13/16	-	-
6676 25 00	1 7/8	-	-
6676 40 00	2 1/4	-	-
6676 50 00	1	-	-
6676 63 00	1	-	-
RA02 L8 00	7 1/4	-	-
RA04 L8 00	-	7 1/16	7 5/16
RA04 L8 L3	-	6 1/2	7 5/16
RA04 L8 L1	-	6 1/2	7 5/16
RA04 L8 63	-	6 1/2	8 11/16
RA66 L8 L1	210	-	-
RA66 L8 L3	210	-	-
RA69 25 17	1 7/8	-	-
RA69 40 25	2 1/4	-	-
RA69 50 25	2 5/8	-	-

	Z	Z1	Z2
RX02 L1 00	7 7/16	-	-
RX02 L3 00	8 11/16	-	-
RX04 L1 00	-	5 11/16	5 11/16
RX04 L3 00	-	6 1/8	5 5/16
RX04 L3 L1	-	6 1/8	5 5/16
RX24 L1 40	-	5 11/16	4 1/8
RX24 L1 63	-	5 11/16	6 7/16
RX24 L3 40	-	6 1/8	4 5/8
RX24 L3 63	-	6 1/8	6 15/16
RX64 L1 63	13 7/8	-	-
RX64 L3 63	14 5/8	-	-
RX66 L3 L1	7 5/8	-	-
VR02 L1 00	4 9/16	-	-
VR02 L3 00	4 7/8	-	-
VR02 L8 00	5 1/16	-	-

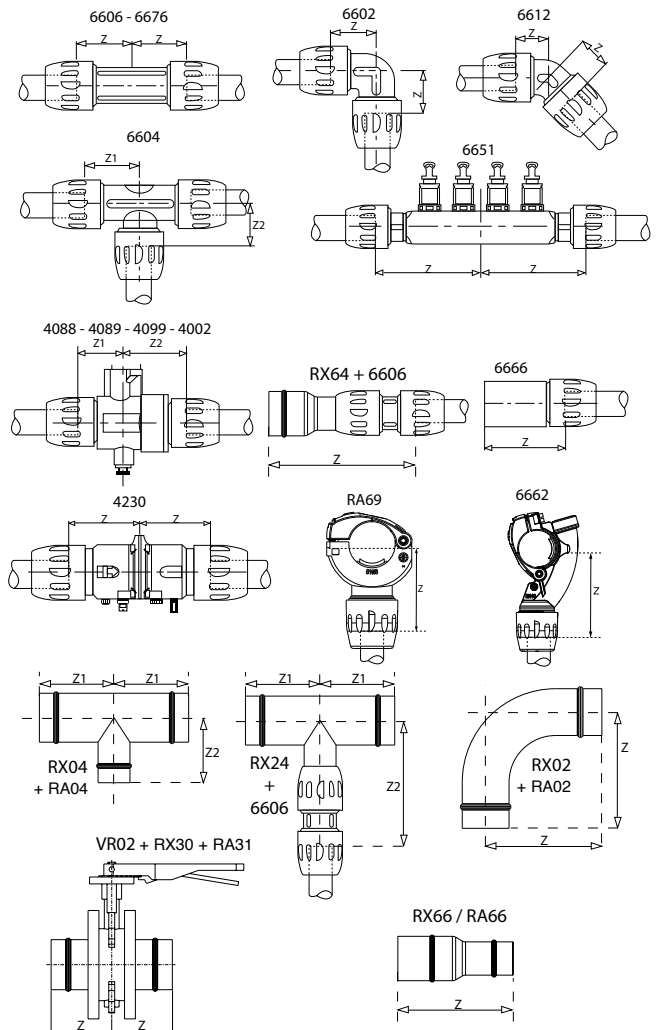

## Expansion / Contraction

L: length of Transair® straight line to be installed (in m)

$\Delta T$ : difference between temperature when installing and maximum operating temperature (in °C)

$\Delta L$ : line length variation (in mm)

For Transair® 1/2" – 4" aluminum pipe systems:

$$\Delta L = (a \times L) + (0.024 \times L \times \Delta T)$$

1. Expansion related to pipe retraction in the connector
2. Expansion related to temperature variations

	Ø 1/2"	Ø 1"	Ø 1 1/2"	Ø 2"	Ø 2 1/2"	Ø 3"	Ø 4"
9 FT PIPE	A=0.06	A=0.20	A=0.40	A=0.56	A=0.73	A=1.0	A=1.0
20 FT PIPE	-	A=0.10	A=0.20	A=0.29	A=0.38	A=0.50	A=0.50

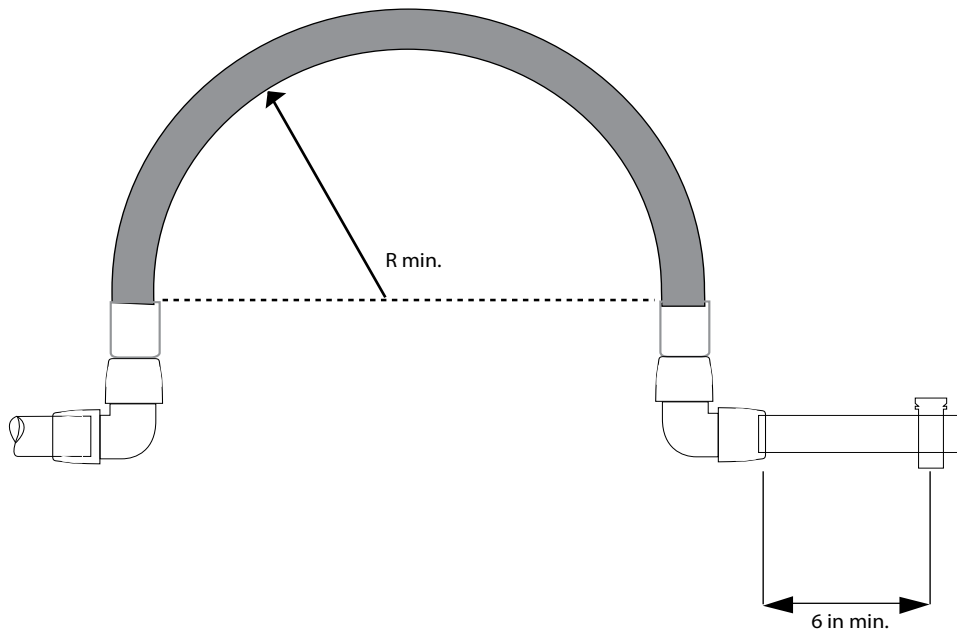

## Practical Information

### Example

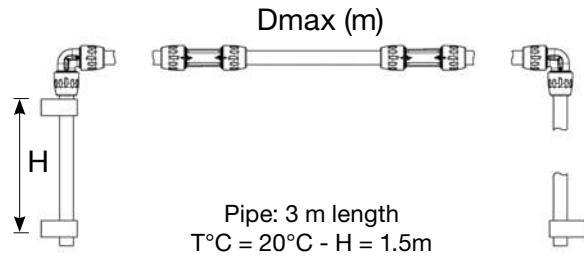
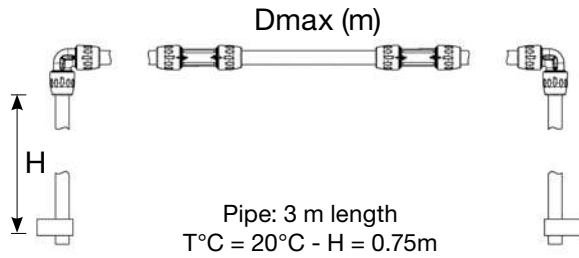

### Case no. 1:

Maximum distance, without expansion loop, from a fixed point dependant on Transair® diameter (2 elbows)

Ø TRANSAIR®	1/2	1	1 1/2	2	2 1/2	3	4
DMAX. (M)	50	40	30	24	24	15	15

### Case no. 2:

Maximum distance, without expansion loop, dependant on Transair® diameter

Ø TRANSAIR®	1/2	1	1 1/2	2	2 1/2	3	4
DMAX. (M)	50	40	30	24	24	15	15

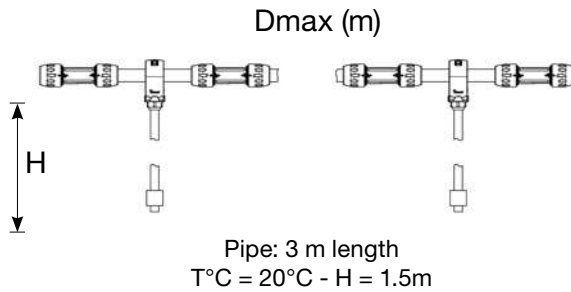
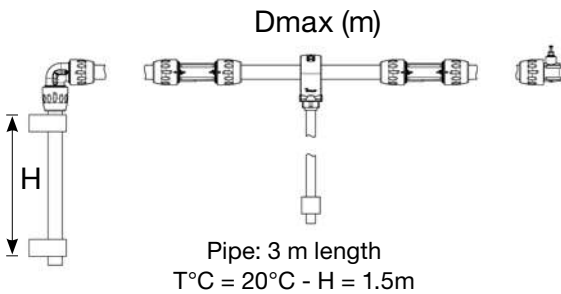

### Case no. 3:

Maximum distance for installing a bracket, without expansion loop, dependant on Transair® diameter (1 elbow - 1 bracket)

Ø TRANSAIR®	1/2	1	1 1/2	2	2 1/2	3	4
DMAX. (M)	48	38	30	25	25	7.5	7.5

### Case no. 4:

Maximum distance for installing a bracket, without expansion loop, dependant on Transair® diameter (2 brackets)

Ø TRANSAIR®	1/2	1	1 1/2	2	2 1/2	3	4
DMAX. (M)	80	70	55	40	40	15	15



## Practical Information

### Direction change

In addition to expansion loops, changes of direction are another method of compensating for expansion and contraction.

- For Transair® 1/2" to 2 1/2" aluminum pipe systems

$H = 29.5"$   $\Delta L1 = 0.6"$

$H = 59.1"$   $\Delta L1 = 1.2"$

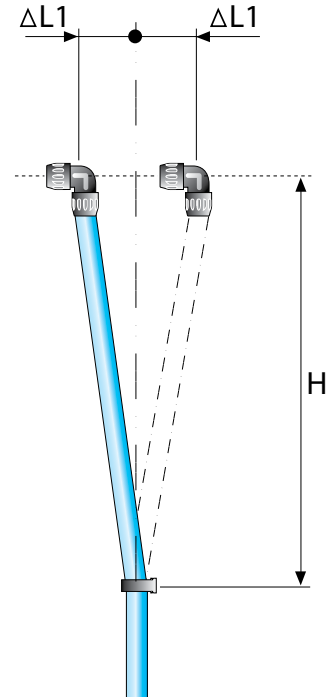

### Using an elbow

- For Transair® 3" to 6" aluminum pipe systems

$H = 29.5"$   $\Delta L1 = 3/8"$

$H = 59.1"$   $\Delta L1 = 6/8"$

### Using a quick assembly bracket

- For Transair® 1/2" to 2 1/2" aluminum pipe systems

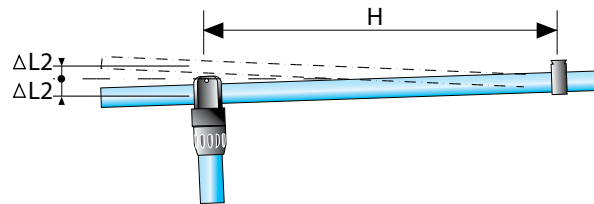

Ø1 (IN)	Ø2 (IN)	H (FT)	ΔL2 (IN)	ΔL3 (IN)
1	1/2	5	1/2	1
1	1	5	1/2	1
1 1/2	1/2	5	1/2	1
1 1/2	1	5	1/2	1
2	1/2	5	1/2	1
2	1	5	1/2	1
2 1/2	1	5	1/2	1

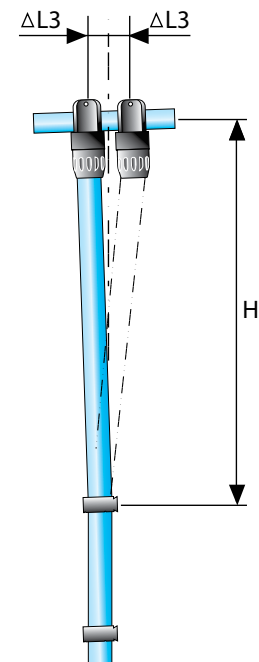

The length variation  $\Delta L$ , calculated for the Transair® line, must always be equal to or less than  $\Delta L2$  and  $\Delta L3$ . If this is not the case, then an expansion loop, using Transair® flexible hose, must be added.

## Practical Information

### Expansion / Contraction

#### Changing direction with a tee

For Transair® 3" - 6" aluminum pipe systems

Ø	Ø (MM)	H (FT)	ΔL2 MAXI (IN)	ΔL3 MAXI (IN)
3	76	2 1/2	3/8	3/8
4	101	2 1/2	3/8	3/8
6	168	2 1/2	3/8	3/8

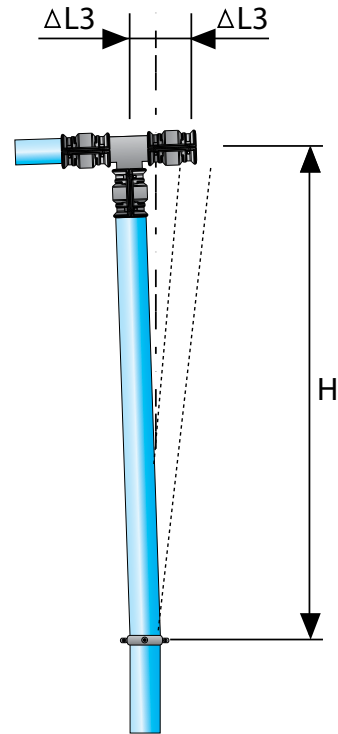
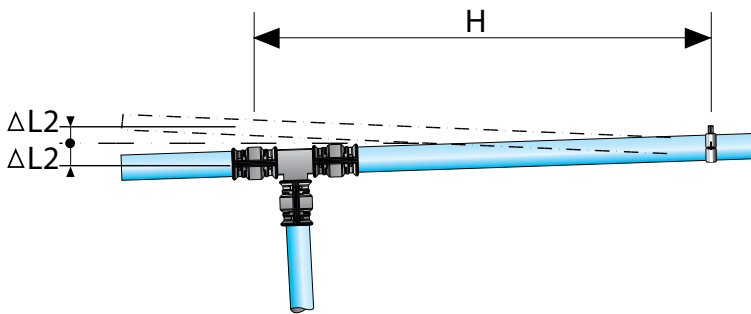

## Practical Information

### Conversion charts

#### Length

INCH (IN)	FOOT (FT)	METER (M)	MILLIMETER (MM)	YARD (YD)
0.39	0.03	0.01	10	0.01
0.79	0.07	0.02	20	0.02
1.18	0.10	0.03	30	0.03
1.57	0.13	0.04	40	0.04
1.97	0.16	0.05	50	0.05
2.36	0.20	0.07	60	0.06
2.76	0.23	0.08	70	0.07
3.15	0.26	0.09	80	0.08
3.54	0.30	0.10	90	0.09
3.94	0.33	0.11	100	0.10
5.91	0.49	0.16	150	0.15
7.87	0.66	0.22	200	0.20
9.84	0.82	0.27	250	0.25
11.81	0.98	0.33	300	0.30
13.78	1.15	0.38	350	0.35
15.75	1.31	0.44	400	0.40
17.72	1.48	0.49	450	0.45
19.69	1.64	0.55	500	0.50
21.65	1.80	0.60	550	0.55
23.62	1.97	0.65	600	0.60
27.56	2.30	0.76	700	0.70
31.50	2.62	0.87	800	0.80
35.43	2.95	0.98	900	0.90
39.37	3.28	1.09	1000	1.00

#### Pressure

BAR	KILO PASCAL (KPA)	ATMOSPHERE (ATM)	PSI	TORR (MM HG)
1	100	0.99	14.50	750
2	200	1.97	29.00	1 500
3	300	2.96	43.50	2 250
4	400	3.95	58.00	3 000
5	500	4.93	72.50	3 750
6	600	5.92	87.00	4 500
7	700	6.91	101.50	5 250
8	800	7.90	116.00	6 000
9	900	8.88	130.50	6 750
10	1000	9.87	145.00	7 500
11	1100	10.86	159.50	8 250
12	1200	11.84	174.00	9 000
13	1300	12.83	188.50	9 750
14	1400	13.82	203.00	10 500
15	1500	14.80	217.50	11 250
16	1600	15.79	232.00	12 000
20	2000	19.74	290.00	15 000

## Practical Information

### Flow Rate

LITERS PER SECOND (L/S)	LITERS PER MINUTE (L/MIN)	CUBIC METERS PER MINUTE (M3/MIN)	CUBIC METERS PER HOUR (M3/H)	CUBIC FEET PER MINUTE (CFM)
10	600	0.60	36	21
20	1 200	1.20	72	42
30	1 800	1.80	108	64
40	2 400	2.40	144	85
50	3 000	3.00	180	106
60	3 600	3.60	216	127
70	4 200	4.20	252	148
80	4 800	4.80	288	169
90	5 400	5.40	324	191
100	6 000	6.00	360	212
150	9 000	9.00	540	318
200	12 000	12.00	720	424
250	15 000	15.00	900	530
300	18 000	18.00	1 080	635
350	21 000	21.00	1 260	741
400	24 000	24.00	1 440	847
450	27 000	27.00	1 620	953
500	30 000	30.00	1 800	1 059
550	33 000	33.00	1 980	1 165
600	36 000	36.00	2 160	1 271
700	42 000	42.00	2 520	1 483
800	48 000	48.00	2 880	1 694
900	54 000	54.00	3 240	1 906
1 000	60 000	60.00	3 600	2 118

### Air Consumption Values

TOOLS	TYPICAL CFM CONSUMPTION AT AN OPERATING PRESSURE OF 87 PSI (5.9 bar)
SMALL PROCESS CONTROLS, INSTRUMENTATION, PNEUMATIC LOGIC UNITS	4
PAINT SPRAY GUN, SMALL IMPACT WRENCH, LIGHT/MEDIUM DRILL, BLOWGUN	FROM 5 TO 18
POLISHER, SCREWDRIVER	25
SHEET METAL CUTTER, LARGE IMPACT WRENCH, AUTOMATIC PLANE	28
SMALL AUTOMATIC MACHINES, MISCELLANEOUS TOOLING	32
LARGE TOOLS, POWER MACHINES AND ASSOCIATED EQUIPMENT	36
AIR HOIST, GRINDER	74

# Transair® systems in use



**Packaging**  
Transair® 1-1/2" (40 mm) and 1" (25 mm)



**Manufacturing**  
Transair® 1" (25 mm) to 6" (168 mm)



**Automotive**  
Transair® 1-1/2" (40 mm)



**Food and beverage**  
Transair® 1" (25 mm)



**Manufacturing**  
SCOUT™ 2-1/2" (63 mm)



**Alternative energy**  
Transair® 2-1/2" (63 mm) and 3" (76 mm)

# Transair® systems in use



**Manufacturing**  
SCOUT™ 2" (50 mm)



**Pharmaceutical**  
Transair® 2-1/2" (63 mm)



**Industrial**  
Transair® 4" (101 mm)



**Outdoor installation**  
Transair® 6" (168 mm)



**Railways**  
Transair® 2-1/2" (63 mm)



**Inert gas**  
Transair® 3" (76 mm)





# Transair<sup>®</sup> Stainless Steel Range

FOR INDUSTRIAL WATER,  
COMPRESSED AIR, VACCUM  
AND INERT GAS

Technical Information

Product Range

Installation Guide

Stainless Steel Drops







# Technical Specifications

## Fluids

- Industrial water
- System compatible with additives (glycol or inhibitors) which prevent the formation of algae or fungus (list available upon request)
- Lubricating oils
- Compressed air (dry, wet, lubricated)
- Vacuum
- Inert gases (argon, nitrogen)
- Others: please consult us

## Maximum Working Pressure According to the Temperature

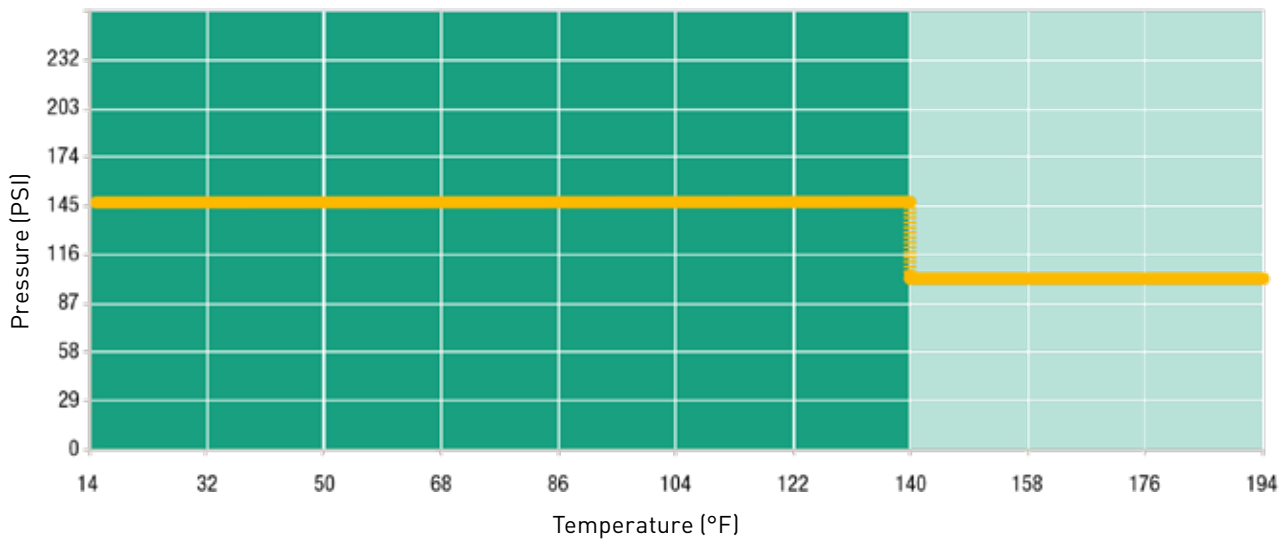

## Working Pressure

- 145 psi from 14°F to 140°F
- 100 psi from 14°F to 194°F

## Expansion Coefficient

- Expansion coefficient of Transair® stainless steel pipe: 0.016 mm per metre per degree celcius

## Resistance

- to corrosion
- to aggressive environments
- to mechanical shocks
- to thermal variations
- to U.V.

**Environment and Sustainable Development Transair® materials are 100% recyclable.**

## Water Hammer

Ø22, Ø28: comply with standard BS, 7291 part 1  
 Ø42, Ø60, Ø76, Ø101: comply with standard NF T54-091

**WARNING:** This product can expose you to chemicals including Lead and Lead Compounds which is known to the State of California to cause cancer and birth defects or other reproductive harm. For more information go to [www.P65Warnings.ca.gov](http://www.P65Warnings.ca.gov)



# Chemical Compatibility

**1** Compatible      **2** Compatible (except for diameters 22-28 mm in bronze)      **3** Do not use

CHEMICAL PRODUCT	SYMBOL	SEAL SELECTION	
		EPDM	FKM
ACETALDEHIDE, ALDEHID ACID	C2H4O	2	3
ACETIC ACID (10%, 20°C)	CH3COOH	2	3
ACETIC ACID (50%, 20°C)	CH3COOH	3	3
ACETONE, PROPAN-2-ONE, DIMETHYL CETONE	C3H6O	1	3
AIR (DRY)		1	1
AIR (LUBRICATED)		3	1
AMMONIA LIQUID	NH3 + H2O	2	3
AMMONIUM HYDROXIDE	NH4OH	3	3
AMMONIUM NITRATE		2	2
AMMONIUM PHOSPHATE		3	2
ARGON (GAS)	AR	1	1
BORIC ACID (23°C)	H3BO3	1	1
BRINE	NaCl + H2O	2	2
CALCIUM HYDROXIDE, SLAKED LIME	CA(OH)2	1	1
CARBOLIC ACID		3	3
CARBON MONOXIDE (60°C)	CO	1	1
CARBON DIOXIDE (DRY)	CO2	1	1
CARBON DIOXYDE (WET OR 60°C)	CO2	3	2
CARBON SULFITE		3	2
CHLORINE (SEA CHLORINATED FLUID)		3	3
CITRIC ACID (50%)	C6H8O7	2	2
DIACETONE ALCOHOL	C6H12O2	1	3
ETHANE-DIOL, MONOETHYLENE GLYCOL, MEG	C2H6O2	2	2
ETHYLENE GLYCOL	C2H4 (OH)2	1	1
FORMIC ACID, METHANOIC ACID	CH2O2	3	3
GALLIC ACID (5%)	C7H6O5	1	1
GLYCOL		1	1
GLYCOLIC ACID (50%)		3	3
HELIUM (GAS)	HE	1	1
HYDRAULIC FLUID - MINERAL OIL	-	3	1
HYDRAULIC FLUID - PETROLEUM BASED	-	3	1
HYDRAULIC FLUID - SILICONE BASED	-	1	1
HYDROFLUORIDRIC ACID	HF	3	3
HYDROGEN BROMIDE (20%)	HBR	3	3
HYDROGEN PEROXIDE (30%)	H2O2	3	1
HYDROGEN SULFIDE	H2S	3	3
HYDROCHLORIC ACID (3%), HYDROGEN CHLORIDE	HCl	3	3

CHEMICAL PRODUCT	SYMBOL	SEAL SELECTION	
		EPDM	FKM
METHANOL, METHYL ALCOHOL (MKB, MEK, MIBK)		1	3
METHYL ALCOHOL	CH4O	1	3
MINERAL OIL		3	1
MOTOR OIL		3	1
MPG, MONO PROPYLEN GLYCOL	C3H8O2	2	2
NAPHTA		3	1
NITRIC ACID	HNO3	3	3
NITROGEN (GAS)	N	1	1
OIL ASTM N°1		3	1
OIL ASTM N°2		3	1
OIL ASTM N°3		3	1
OXALIQUE ACID (10%, 23°C)	HOOC-COOH	2	2
OXYGEN (>20%)	O	3	3
OZONE	O	2	2
PERCHLORIC ACID (70%)		3	3
PHOSPHATE ESTER HYDRAULIC FLUID, SKYDROL		1	3
PHOSPHORIC ACID, ORTHOPHOSPHORIC ACID	H3PO4	2	2
POTASSIUM HYDROXIDE (50%, 85°C)	KOH	2	3
SEA WATER	H2O, NaCl	2	2
SILICON EMULSIONS		1	1
SODIUM BICARBONATE, BAKING SODA (23°C)		1	1
SODIUM CARBONATE		1	1
SODIUM HYDROXIDE, CAUSTIC SODA (50%)	NaOH	2	3
SODIUM NITRITE		2	2
SODIUM PEROXIDE	Na2O2	3	3
SODIUM PHOSPHATE	Na3PO4	2	2
SODIUM SULPHATE	Na2SO4	1	1
AQUEOUS SOLUTION OF DETERGENT		2	2
SULFURIC ACID (10%, 20°C)	H2SO4	3	3
TARTRIC ACID (50%, 23°C)		3	2
TRICHLOROETHYLENE, TRICHLORIDE ETHYLENE	C2HCl3	3	3
TRITHANOLAMINE, TEA	C6H15O3N	2	3
WATER DEMINERALISED	H2O	2	2
WATER DRINKABLE	H2O	3	3
WATER INDUSTRIAL	H2O	1	1
WATER WITH CHLORINE (5%, 23°C)	H2O, Cl, NaOCl	3	3

This information is given for information only. For further information and specific conditions of use, please contact our technical department.

**WARNING:** This product can expose you to chemicals including Lead and Lead Compounds which is known to the State of California to cause cancer and birth defects or other reproductive harm. For more information go to [www.P65Warnings.ca.gov](http://www.P65Warnings.ca.gov)

# Sizing A Network

- Select the Transair® diameter for your application, based on required flow against pressure drop.
- Estimated values for a closed loop network, a pressure of 4 bar with less than 10% pressure drop.
- Velocity: 4 m/s.

ESTIMATED FLOW RATE				EQUIVALENT LENGTH									
				32.8 FT	65.6 FT	98.4 FT	131.2 FT	164 FT	246 FT	328 FT	492 FT	656 FT	984 FT
M3/H	L/S	L/MIN	CFM	10 M	20 M	30 M	40 M	50 M	75 M	100 M	150 M	200 M	300 M
0,5	0,14	8	0,3	22	22	22	22	22	22	22	22	22	28
1	0,28	17	0,6	22*	22*	22*	22*	22*	28	28	28	28	42
2,5	0,69	42	1,5	22*	28*	28*	28*	42	42	42	42	42	42
3,5	0,97	58	2,1	28	28	42	42	42	42	42	42	42	60
5	1,39	83	3	28*	42*	42*	42*	42*	42*	42*	60	60	60
10	2,77	167	6	42*	42*	42*	60*	60*	60*	60*	60*	76	76
15	4,17	250	9	42*	60*	60*	60*	60*	60*	76	76	76	76
20	5,56	333	12	60*	60*	60*	60*	60*	76*	76*	76*	100	100
30	8,33	500	18	60*	60*	76*	76*	76*	76*	100*	100*	100*	100*
40	11,11	667	24	76*	76*	76*	76*	76*	100*	100*	100*	100*	
50	13,89	833	29	76*	76*	76*	100*	100*	100*	100*			
75	20,83	1250	44	100*	100*	100*	100*	100*					
80	22,22	1333	47	100*	100*	100*	100*	100*					
100	27,78	1667	59	100*	100*	100*	100*						

\* These results should be taken into account in order to ensure the best practice for industrial water networks. An anti-water hammer device is necessary for the protection of regulation components of other fragile elements.

## Example (with the above values)

- Main System Linear Length (Closed Loop): 164ft
- Required Flow Rate: 9cfm
- Working Pressure: 58psi
- Pressure Drop < 10%
- Velocity: 13.1ft/s
- The most suitable Transair Stainless Steel Diameter is: 60mm (2")

## DIN 1988

The pressure drop per diameter is stated for a flow rate and a velocity, at a temperature of 20°C. Technical data sheet available upon request.

**WARNING:** This product can expose you to chemicals including Lead and Lead Compounds which is known to the State of California to cause cancer and birth defects or other reproductive harm. For more information go to [www.P65Warnings.ca.gov](http://www.P65Warnings.ca.gov)

# Transair® Standards And Certifications

Transair® stainless steel range certifications fall within the standard and regulation universe described on pages 8 and 9 of this catalog.

## Standards Related to Transair® Stainless Steel Pipe



Transair® stainless steel range conforms to the standards below related to mechanical and chemical properties per diameter.

	Ø 22 - Ø 28	Ø 42 - Ø 60	Ø 76 - Ø 101
<b>MANUFACTURING STANDARDS</b>	EN 10217-7	EN 10217-7	EN 10217-7
<b>GRADE</b>	EN 10088-2, 4404, AISI 316L	1.4301 / AISI 304	1.4301 / AISI 304
<b>WELDING STANDARD</b>	DIN 17 457, EN 10217-7	DIN 17 457, EN 10217-7	DIN 17 457, EN 10217-7
<b>TOLERANCES</b>	DVGW - W541	EN 1127D4/T3	EN 1127D4/T3

The quality of the raw materials used in Transair stainless steel pipes allows for them to be bent according to best practices. See page E35 for details.

## Applications



### FDA Certificate – CFR 21

Transair® stainless steel drops diameter 22mm presented on page E39 of this catalog conform to FDA – CFR 21 requirements.

## Safety



### UL94 HB Grade Certificate

All Transair® components are non-flammable with no propagation of flame.

Pipe-to-pipe connectors, ball valves and butterfly valves conform to UL 94 HB Grade standards.

The above mentioned certificates are available upon request.

**WARNING:** This product can expose you to chemicals including Lead and Lead Compounds which is known to the State of California to cause cancer and birth defects or other reproductive harm. For more information go to [www.P65Warnings.ca.gov](http://www.P65Warnings.ca.gov)



# Material Stainless Steel Range

	Ø22 - Ø28	Ø42 - Ø60	Ø76 - Ø101
PIPE	316L STAINLESS STEEL	304 STAINLESS STEEL	304 STAINLESS STEEL
CONNECTOR	BODY: BRONZE GRIPPING RING: STAINLESS STEEL RETAINING CAP: HR POLYMER	BODY: HR POLYMER NUT: HR POLYMER CLAMP: HR POLYMER	CLAMP: TREATED STEEL CARTRIDGE: HR POLYMER AND STAINLESS STEEL
90° ELBOW	BODY: BRONZE GRIPPING RING: STAINLESS STEEL RETAINING CAP: HR POLYMER	BODY: HR POLYMER NUT: HR POLYMER	304 STAINLESS STEEL
45° ELBOW	-	304 STAINLESS STEEL	304 STAINLESS STEEL
TEE	BODY: BRONZE GRIPPING RING: STAINLESS STEEL RETAINING CAP: HR POLYMER	BODY: HR POLYMER NUT: HR POLYMER	304 STAINLESS STEEL
REDUCING TEE	BODY: BRONZE GRIPPING RING: STAINLESS STEEL RETAINING CAP: HR POLYMER	-	304 STAINLESS STEEL
IN-LINE REDUCER	BODY: BRONZE GRIPPING RING: STAINLESS STEEL RETAINING CAP: HR POLYMER	TREATED BRASS	304 STAINLESS STEEL
END-CAP	BODY: BRONZE GRIPPING RING: STAINLESS STEEL RETAINING CAP: HR POLYMER	304 STAINLESS STEEL	304 STAINLESS STEEL
MALE STUD FITTING	BODY: BRONZE GRIPPING RING: STAINLESS STEEL RETAINING CAP: HR POLYMER	-	-
MALE ADAPTOR	-	TREATED BRASS	TREATED BRASS
WALL BRACKET	TREATED BRASS	-	-
BUTTERFLY VALVE	-	BODY: IRON HANDLE: ALUMINIUM	BODY AND HANDLE: IRON DISC AND SHAFT: STAINLESS STEEL HANDLE: ALUMINIUM
QUICK ASSEMBLY BRACKET	-	IRON AND TREATED STEEL	IRON AND TREATED STEEL
FLANGE	-	304 STAINLESS STEEL	304 STAINLESS STEEL
BALL VALVE	STAINLESS STEEL WITH PTFE SEATS & SEALS BRASS WITH PTFE SEATS & SEALS		
FIXING CLIP	304 STAINLESS STEEL		
NON SLIP CLIP	COLLAR: ZINC-PLATED STEEL LINING: ELASTOMER		
THREADED ROD	STEEL		
SCREW TYPE BEAM CLAMP	FORMED STEEL		

All seals are available in EPDM or FKM (unless otherwise stated).

**WARNING:** This product can expose you to chemicals including Lead and Lead Compounds which is known to the State of California to cause cancer and birth defects or other reproductive harm. For more information go to [www.P65Warnings.ca.gov](http://www.P65Warnings.ca.gov)

# Transair® Connection Technologies

Transair® innovative technology takes into account the specific requirements of each diameter and provides the user with an optimum safety coefficient and easy connection.

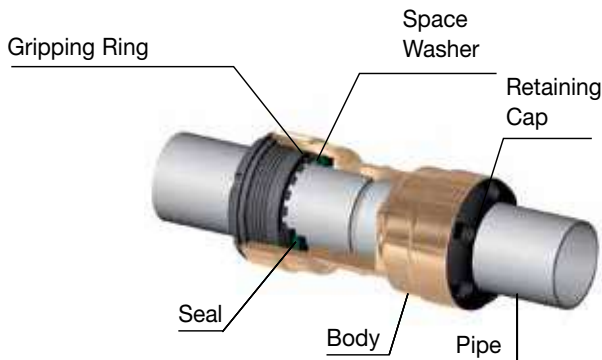

## 22 - 28mm

Pipe-to-pipe and stud connectors in Ø22 and Ø28 can be immediately connected to Transair® stainless steel -pipe – simply push the pipe into the connector up to the connection mark. The gripping ring of each fitting is then automatically secured and the connection is safe.



## 42 - 60mm

Pipe-to-pipe and stud connectors in Ø42 and Ø60 can be quickly connected to Transair® stainless steel pipe by means of a double clamp ring. This secures the connection between the nut and the pipe – tightening of the nuts secures the final assembly.

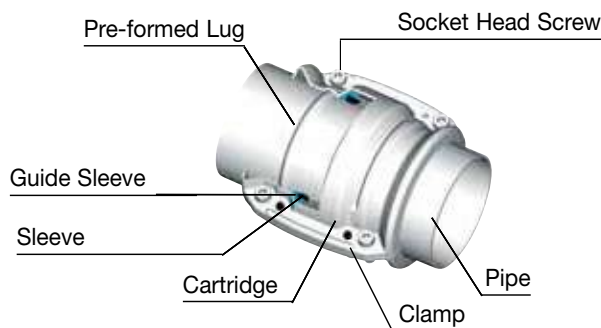

## 76 - 101mm

Pipe-to-pipe and stud connectors in Ø76 and Ø101 can be quickly connected to Transair® stainless steel pipe. Position the pipes to be connected within the Transair® cartridge and close/tighten the Transair® clamp.

**WARNING:** This product can expose you to chemicals including Lead and Lead Compounds which is known to the State of California to cause cancer and birth defects or other reproductive harm. For more information go to [www.P65Warnings.ca.gov](http://www.P65Warnings.ca.gov)

# Stainless Steel Pipe

Diameter: 1/2" to 4"

Stainless Steel Pipe AISI 316L



PART NO.	OD (IN)	OD (MM)	NOMINAL LENGTH (FT)	WEIGHT (LB)
TF16 N7 00	1/2	22	20	8.2
TF16 N9 00	1	28	20	10.8

PART NO.	OD (IN)	OD (MM)	NOMINAL LENGTH (FT)	WEIGHT (LB)
TX16 M4 00	1-1/2	42	20	21.6
TX16 M6 00	2	60	20	31.1

PART NO.	OD (IN)	OD (MM)	NOMINAL LENGTH (FT)	WEIGHT (LB)
TX16 L1 00	3	76	20	39.5
TX16 L3 00	4	101	20	65.98

## Standards

	Ø 22 - Ø 28	Ø 42 - Ø 60	Ø 76 - Ø 101
MANUFACTURING STANDARDS	EN 10217-7	EN 10217-7	EN 10217-7
GRADES	EN 10088-2, 1.4404 / AISI 316 L	1.4301 / AISI 304	1.4301 / AISI 304
WELDING STANDARDS	DIN 17 457, EN 10217-7	DIN 17 457, EN 10217-7	DIN 17 457, EN 10217-7
TOLERANCES	DVGW - W541	EN 1127 D4 / T3	EN 1127 D4 / T3

## Volume and Mass

				VALUE FOR 1 METRE OF PIPE					
Ø EXT		Ø INT		VOLUME		PIPE MASS		MASS OF THE NETWORK FULL OF WATER	
(IN)	(MM)	(IN)	(MM)	GALLON	LITER	(LB)	(KG)	(LB)	(KG)
.87	22.0	.77	19.6	.07	.30	1.38	.627	2.04	.929
1.10	28.0	1	25.6	.13	.51	1.78	.808	2.91	1.323
1.67	42.3	1.53	39.1	.31	1.20	3.56	1.616	6.21	2.817
2.37	60.3	2.24	57.1	.67	2.56	5.13	2.331	10.78	4.892
3	76.1	2.87	72.9	1.10	4.17	6.52	2.958	15.72	7.132
4	101.6	3.84	97.6	1.97	7.48	10.89	4.944	27.39	12.425

Please consult the installation guide on page E24 of this catalog for pipe installation.

**WARNING:** This product can expose you to chemicals including Lead and Lead Compounds which is known to the State of California to cause cancer and birth defects or other reproductive harm. For more information go to [www.P65Warnings.ca.gov](http://www.P65Warnings.ca.gov)



# Pipe-to-Pipe and Stud Connectors

The range of Transair® pipe-to-pipe and stud connectors provides versatility of design.

- Quick connection
- Dismountable and reusable
- Full bore design (consistent inner diameter for both pipe and connectors)

## Diameters: 3/4" to 1" Union Connector

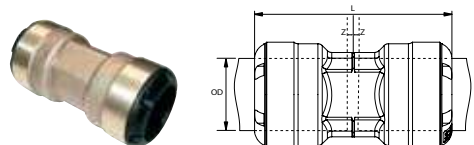

PART NO.	SEAL	OD (IN)	OD (MM)	L (IN)	Z (IN)	WEIGHT (LB)
RR06 N7 01	EPDM	3/4	22	2.49	.05	.28
RR06 N7 02	FKM	3/4	22	2.49	.05	.28
RR06 N9 01	EPDM	1	28	3.37	.05	.55
RR06 N9 02	FKM	1	28	3.37	.05	.55

## Diameters: 1 1/2" to 2" Union Connector

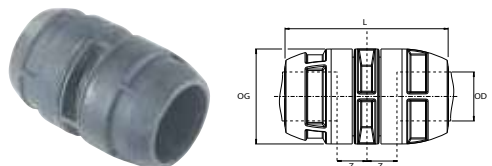

PART NO.	SEAL	OD (IN)	OD (MM)	L (IN)	Z (IN)	WEIGHT (LB)
RP06 M4 01	EPDM	1-1/2	42	6.10	.10	1.09
RP06 M4 02	FKM	1-1/2	42	6.10	.10	1.09
RP06 M6 01	EPDM	2	60	6.14	.10	1.45
RP06 M6 02	FKM	2	60	6.14	.10	1.45

## Diameters: 3" to 4" Union Clamp

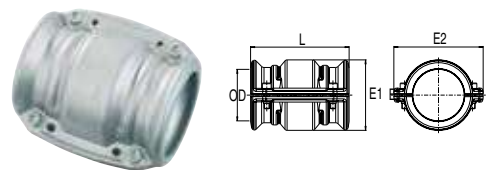

PART NO.	SEAL	OD (IN)	OD (MM)	L (IN)	WEIGHT (LB)
RR01 L1 01	EPDM	3	76	5.75	2.5
RR01 L1 02	FKM	3	76	5.75	2.5
RR01 L3 01	EPDM	4	101	5.75	3.27
RR01 L3 02	FKM	4	101	5.75	3.27

## Diameters: 3/4" to 1" 90° Elbow

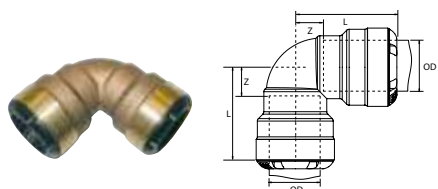

PART NO.	SEAL	OD (IN)	OD (MM)	L (IN)	Z (IN)	WEIGHT (LB)
RR02 N7 01	EPDM	3/4	22	1.72	.52	.36
RR02 N7 02	FKM	3/4	22	1.72	.57	.36
RR02 N9 01	EPDM	1	28	2.2	.52	.59
RR02 N9 02	FKM	1	28	2.2	.57	.59

**WARNING:** This product can expose you to chemicals including Lead and Lead Compounds which is known to the State of California to cause cancer and birth defects or other reproductive harm. For more information go to [www.P65Warnings.ca.gov](http://www.P65Warnings.ca.gov)

**Diameters: 1 1/2" to 2"**

**90° Elbow**

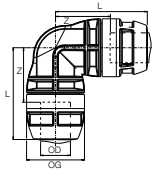

PART NO.	SEAL	OD (IN)	OD (MM)	L (IN)	Z (IN)	WEIGHT (LB)
RP02 M4 01	EPDM	1 1/2	42	5.12	2.17	1.33
RP02 M4 02	FKM	1 1/2	42	5.12	2.52	1.33
RP02 M6 01	EPDM	2	60	5.47	2.17	1.82
RP02 M6 02	FKM	2	60	5.47	2.52	1.82

**Diameters: 3" to 4"**

**90° Elbow**

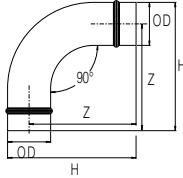

PART NO.	OD (IN)	OD (MM)	Z (IN)	WEIGHT (LB)
RX02 L1 00	3	76	7.44	2.28
RX02 L3 00	4	101	10.94	3.13

Use 2 connectors RR01 to connect elbow RX02 to Transair® stainless steel pipe.

**Diameters: 1 1/2" to 2"**

**45° Elbow**

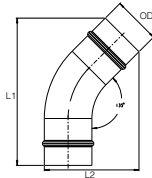

PART NO.	ØD (IN)	ØD (MM)	L1 (IN)	L2 (IN)	WEIGHT (LB)
RX12 M4 00	N/A	1 1/2	42	11.34	1.07
RX12 M6 00	N/A	2	60	11.81	1.17

Use 2 connectors RP06 to connect elbow RX12 to Transair® stainless steel pipe.

**Diameters: 3" to 4"**

**45° Elbow**

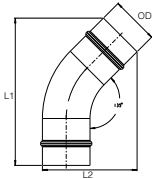

PART NO.	ØD (IN)	ØD (MM)	L1 (IN)	L2 (IN)	WEIGHT (LB)
RX12 L1 00	N/A	3	76	9.27	1.56
RX12 L3 00	N/A	4	101	10.69	2.89

Use 2 connectors RR01 to connect elbow RX12 to Transair® stainless steel pipe.

**Diameters: 1 1/2" to 2"**

**Equal Tee**

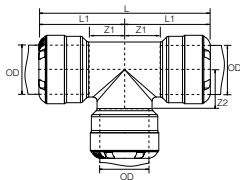

PART NO.	SEAL	OD (IN)	OD (MM)	L1 (IN)	L2 (IN)	Z1 (IN)	Z2 (IN)	WEIGHT (LB)
RR04 N7 01	EPDM	1/2	22	1.66	1.72	.46	.43	.47
RR04 N7 02	FKM	1/2	22	2.20	1.72	.57	.57	.47
RR04 N9 01	EPDM	1	28	1.66	2.20	.46	.43	.86
RR04 N9 02	FKM	1	28	2.20	2.20	.57	.57	.86

**WARNING:** This product can expose you to chemicals including Lead and Lead Compounds which is known to the State of California to cause cancer and birth defects or other reproductive harm. For more information go to [www.P65Warnings.ca.gov](http://www.P65Warnings.ca.gov)



**Diameters: 1 1/2" to 2"** **Equal Tee**

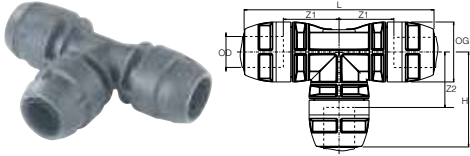

PART NO.	SEAL	OD (IN)	OD (MM)	L (IN)	Z1 (IN)	Z2 (IN)	WEIGHT (LB)
RP04 M4 01	EPDM	1 1/2	42	10.24	2.17	2.17	1.98
RP04 M4 02	FKM	1 1/2	42	10.24	2.17	2.17	1.98
RP04 M6 01	EPDM	2	60	10.98	2.52	2.52	2.65
RP04 M6 02	FKM	2	60	10.98	2.52	2.52	2.65

**Diameters: 3" to 4"** **Equal Tee**

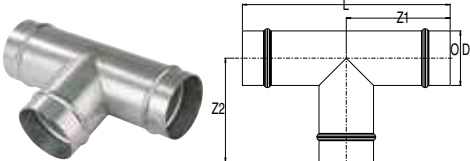

PART NO.	OD (IN)	OD (MM)	L (IN)	Z1 (IN)	Z2 (IN)	WEIGHT (LB)
RX04 L1 00	3	76	11.50	5.71	5.71	2.35
RX04 L3 00	4	101	12.28	6.10	6.10	3.94

Use 3 connectors RR01 to connect equal tee RX04 to Transair® stainless steel pipe Ø76 or Ø101.

**Diameters: 1 1/2" to 2"** **Reducing Tee**

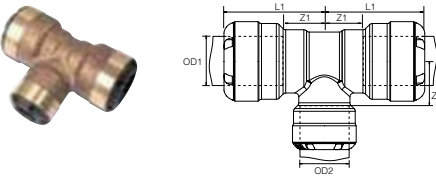

PART NO.	SEAL	OD1 (IN)	OD1 (MM)	OD2 (IN)	OD2 (MM)	L1 (IN)	L2 (IN)	Z1 (IN)	Z2 (IN)	WEIGHT (LB)
RR04 N9 N7 01	EPDM	1	28	1/2	22	2.09	1.83	.45	.64	.33
RR04 N9 N7 02	FKM	1	28	1/2	22	2.09	1.83	.45	.64	.33

**Diameters: 3" to 4"** **Reducing Tee**

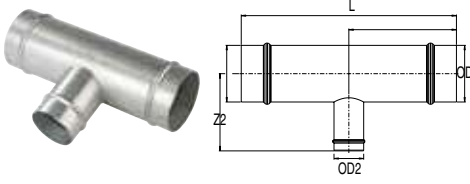

PART NO.	OD1 (IN)	OD1 (MM)	OD2 (IN)	OD2 (MM)	L (IN)	Z1 (IN)	Z2 (IN)	WEIGHT (LB)
RX04 L1 M4	3	76	1 1/2	42	11.42	5.71	7.20	1.03
RX04 L1 M6	3	76	2	60	11.42	5.71	7.20	1.10
RX04 L3 L1	4	101	3	76	12.20	6.10	7.68	1.64
RX04 L3 M4	4	101	1 1/2	42	12.20	6.10	7.68	1.68
RX04 L3 M6	4	101	2	60	12.20	6.10	7.68	1.74

Use 2 connectors RR01 to connect reducing tee RX04 to Transair® stainless steel pipe Ø76 or Ø101 and 1 connector RP06 to connect to Transair® stainless steel pipe Ø42 or Ø60.

PART NO.	OD (IN)	OD (MM)	L (IN)	Z1 (IN)	Z2 (IN)	WEIGHT (LB)
RX04 L1 00	3	76	11.5	5.71	5.71	2.35
RX04 L3 00	4	101	12.28	6.1	6.1	3.94

Use 2 connectors RR01 to connect threaded tee RX23 to Transair® stainless steel pipe Ø76 or Ø101.

**WARNING:** This product can expose you to chemicals including Lead and Lead Compounds which is known to the State of California to cause cancer and birth defects or other reproductive harm. For more information go to [www.P65Warnings.ca.gov](http://www.P65Warnings.ca.gov)

**Diameters: 3" to 4"**

**Female Threaded NPT Tee**

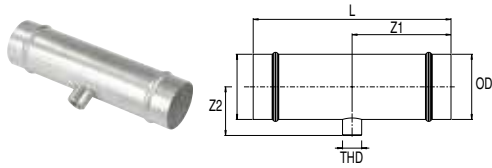

PART NO.	OD (IN)	OD (MM)	THD SIZE (IN)	L (IN)	Z1 (IN)	Z2 (IN)	WEIGHT (LB)
RX20 L1N04	3	76	3/4	11.50	5.71	2.48	1.97
RX20 L3N04	4	101	3/4	12.28	6.10	2.98	3.45

**Diameters: 1 1/2" to 2"**

**Female Threaded NPT Plug-In Reducer**

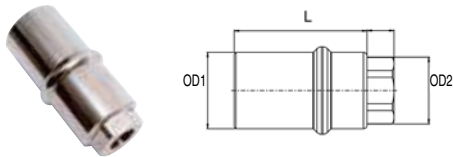

PART NO.	OD1 (IN)	OD1 (MM)	THD SIZE (IN)	L (IN)	WEIGHT (LB)
RR65 M6N06	1 1/2	42	3/4	3.46	1.32
RR65 M6N08	1 1/2	42	1	63.00	1.76
RR65 M4N06	2	60	3/4	36.22	2.20
RR65 M4N08	2	60	1	36.22	1.87

Use a connector RP06 to connect plug-in reducer RP14 to Transair® stainless steel pipe Ø42 or Ø60 and a connector RR05 to connect to Transair® stainless steel pipe Ø22 or Ø28.

**Diameters: 2" to 4"**

**Plug-In Reducer**

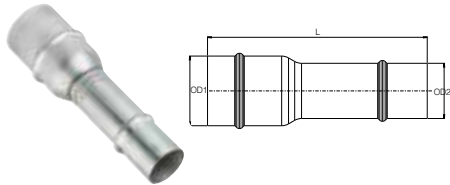

PART NO.	OD1 (IN)	OD1 (MM)	OD2 (IN)	OD2 (MM)	L (IN)	WEIGHT (LB)
RX66 M6 M4	2	60	1 1/2	42	8.66	.83
RX66 L1 M6	3	76	2	60	9.45	1.22
RX66 L3 L1	4	101	3	76	7.56	1.55

Use a connector RR01 to connect plug-in reducer RX66 to Transair® stainless steel pipe Ø76 or Ø101 and a connector RP06 to connect to Transair® stainless steel pipe Ø60.

**Diameters: 1/2" to 1"**

**End Cap**

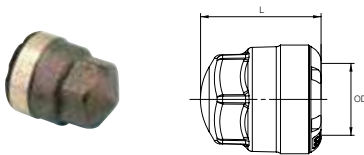

PART NO.	SEAL	OD (IN)	OD (MM)	L (IN)	WEIGHT (LB)
RR25 N7 01	EPDM	3/4	22	1.62	.18
RR25 N7 02	FKM	3/4	22	1.62	.18
RR25 N9 01	EPDM	1	28	2.15	.33
RR25 N9 02	FKM	1	28	2.15	.33

**Diameters: 1-1/2" to 2"**

**End Cap**

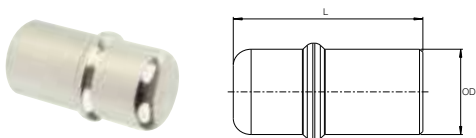

PART NO.	OD (IN)	OD (MM)	L (IN)	WEIGHT (LB)
RR25 M4 00	1 1/2	42	3.35	1.03
RR25 M6 00	2	60	3.35	1.59

**WARNING:** This product can expose you to chemicals including Lead and Lead Compounds which is known to the State of California to cause cancer and birth defects or other reproductive harm. For more information go to [www.P65Warnings.ca.gov](http://www.P65Warnings.ca.gov)

**Diameters: 3" to 4"**

**End Cap**

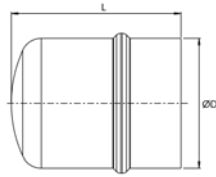

PART NO.	OD (IN)	OD (MM)	L (IN)	WEIGHT (LB)
RX25 L1 00	3	76	4.17	.77
RX25 L3 00	4	101	4.23	1.19

Use 1 connector RR01 to connect end cap RX25 to Transair® stainless steel pipe Ø76 or Ø101.

**Diameters: 3/4" to 1"**

**Male NPT Stud Connector**

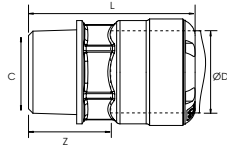

PART NO.	SEAL	OD (IN)	OD (MM)	THD SIZE (IN)	L (IN)	Z (IN)	WEIGHT (LB)
RR05 N7N06 01	EPDM	3/4	22	3/4	2.26	1.07	.33
RR05 N7N06 02	FKM	3/4	22	3/4	2.26	1.07	.33
RR05 N9N08 01	EPDM	1	28	1	2.89	1.67	.57
RR05 N9N08 02	FKM	1	28	1	2.89	1.67	.57

**Diameters: 1 1/2" to 2"**

**Male Threaded NPT Adapter**

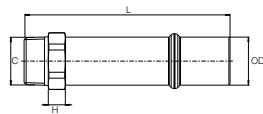

PART NO.	OD (IN)	OD (MM)	THD SIZE (IN)	L (IN)	Z (IN)	WEIGHT (LB)
RR05 M4N06	1 1/2	42	3/4	4.61	.81	1.23
RR05 M4N10	1 1/2	42	1 1/4	7.20	.87	1.98
RR05 M4N12	1 1/2	42	1 1/2	7.20	.87	1.30
RR05 M6N06	2	60	3/4	4.61	.81	2.22
RR05 M6N16	2	60	2	7.56	.87	3.94
RR05 M6N20	2	60	2 1/2	7.68	.87	2.69

Use 1 connector RP06 to connect end cap RR05 to Transair® stainless steel pipe Ø42 or Ø60.

**Diameter: 3"**

**Male Threaded NPT Adapter**

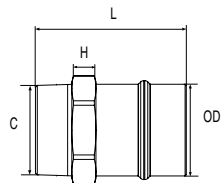

PART NO.	OD (IN)	OD (MM)	THD SIZE (IN)	L (IN)	WEIGHT (LB)
RR21 L1N20	3	76	2.5	4.92	4.34
RR21 L1N24	3	76	3	5.24	6.84

Use 1 connector RR01 to connect end cap RR05 to Transair® stainless steel pipe Ø76.

**WARNING:** This product can expose you to chemicals including Lead and Lead Compounds which is known to the State of California to cause cancer and birth defects or other reproductive harm. For more information go to [www.P65Warnings.ca.gov](http://www.P65Warnings.ca.gov)

**Diameters: 1 1/2" to 4"**

**Flange Adapter**

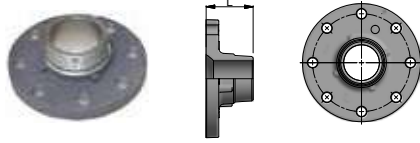

PART NO.	OD (IN)	OD (MM)	STANDARD	D1 (IN)	D2 (IN)	D3 (IN)	L (IN)	WEIGHT (LB)
RX30 M4 00	1 1/2	42	DIN	5.51	3.94	.71	6.42	2.76
RX30 M6 00	2	60	DIN	6.5	4.92	.71	5.55	3.75
RX30 L1 00	3	76	DIN	7.28	5.71	.71	2.95	4.28
RX31 L1 00	3	76	ANSI	7.87	6.29	.74	2.95	7.05
RX30 L3 00	4	101	DIN	8.66	7.09	.71	2.95	5.91
RX31 L3 00	4	101	ANSI	8.99	7.50	.74	2.95	9.76

**Diameters: 1 1/2" to 4"**

**EPDM Gasket For Stainless Steel Flange**

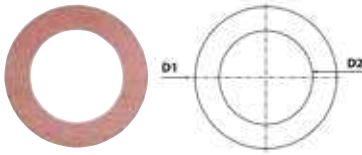

PART NO.	OD (IN)	OD (MM)	FOR USE WITH FLANGE
EW05 M4 01	1 1/2	42	RX30 M4 00
EW05 M6 01	2	60	RX30 M6 00
EW05 L1 01	3	76	RX30 L1 00 / RX31 L1 00
EW05 L3 01	4	101	RX30 L3 00 / RX31 L3 00

**Gasket And Bolt Kits for Assembly Stainless Steel Flange**

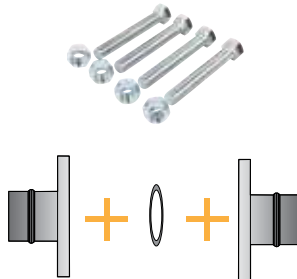

PART NO.	THD SIZE (IN)	L (IN)	NUMBER OF BOLTS
EW06 00 03	5/8"-11	3.5	8
EW10 00 01	5/8"-11	1.23	8

PART NO.	OD (IN)	OD (MM)	GASKET PART NO.	BOLT KIT PART NO.	NUMBER OF KITS	MAX. TIGHTENING TORQUE (FT-LBS)
RX30 M4 00	1 1/2	42	EW05 M4 01	EW06 00 03	1	147.51
RX30 M6 00	2	60	EW05 M6 01	EW06 00 03	1	147.51
RX30 L1 00	3	76	EW05 L1 01	EW10 00 01	1	147.51
RX31 L1 00	3	76	EW05 L1 01	EW10 00 01	1	147.51
RX30 L3 00	4	101	EW05 L3 01	EW10 00 01	2	147.51
RX31 L3 00	4	101	EW05 L3 01	EW10 00 01	2	147.51

# Drop Brackets

**Diameters: 1 1/2" to 2"**

**Quick Assembly Direct Feed Bracket**



PART NO.	SEAL	OD (IN)	OD (MM)	L (IN)	WEIGHT (LBS)
RR89 M4N06 01	EPDM	1 1/2	42	3.46	.99
RR89 M6N06 01	EPDM	2	60	4.61	1.99
RR89 L1N08 01	EPDM	3	76	5.39	4.3
RR89 L3N08 01	EPDM	4	101	6.22	4.33
RR89 M4N06 02	FKM	1 1/2	42	3.46	.99
RR89 M6N06 02	FKM	2	60	4.61	1.99
RR89 L1N08 02	FKM	3	76	5.39	4.3
RR89 L3N08 02	FKM	4	101	6.22	4.33

**WARNING:** This product can expose you to chemicals including Lead and Lead Compounds which is known to the State of California to cause cancer and birth defects or other reproductive harm. For more information go to [www.P65Warnings.ca.gov](http://www.P65Warnings.ca.gov)

# Quick Assembly Brackets and Wall Brackets

**Diameter: 1/2"** **Threaded NPT 1 Port 45° Wall Bracket**

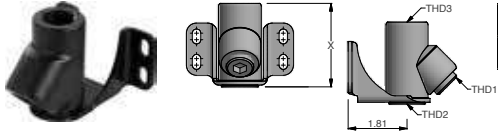

PART NO.	THD SIZE 1 (IN)	THD SIZE 2 (IN)	THD SIZE 3 (IN)	X (IN)
6642 22 22	1/2	1/4	1/2	2.52

**Diameter: 1/2"** **Threaded NPT 2 Port 45° Wall Bracket**

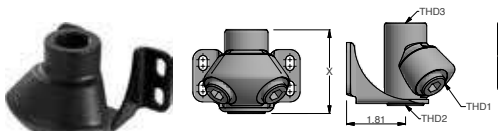

PART NO.	THD SIZE 1 (IN)	THD SIZE 2 (IN)	THD SIZE 3 (IN)	X (IN)
6691 22 22	1/2	1/4	1/2	2.52

**Diameter: 1/2"** **Threaded NPT 2 Port 90° Wall Bracket**

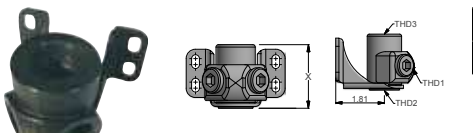

PART NO.	THD SIZE 1 (IN)	THD SIZE 2 (IN)	THD SIZE 3 (IN)	X (IN)
6688 22 22	1/2	1/4	1/2	2.03

**Diameter: 3/4"** **Threaded NPT 3 Port Wall Bracket**

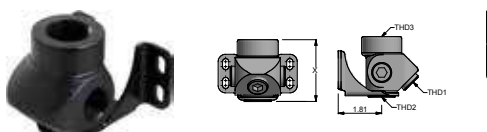

PART NO.	THD SIZE 1 (IN)	THD SIZE 2 (IN)	THD SIZE 3 (IN)	X (IN)
6636 28 22	1/2	1/4	3/4	2.52

**WARNING:** This product can expose you to chemicals including Lead and Lead Compounds which is known to the State of California to cause cancer and birth defects or other reproductive harm. For more information go to [www.P65Warnings.ca.gov](http://www.P65Warnings.ca.gov)

# Ball Valves and Butterfly Valves

Transair® ball valves and butterfly valves placed regularly throughout the network and at key locations allow ease of system isolation, adaptation and maintenance. These valves are silicone-free.

**Diameters: 1 1/2" to 4"**

## Butterfly Valve

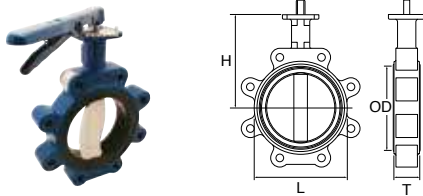

PART NO.	SEAL	FLANGE STD	OD (IN)	OD (MM)	NUMBER OF LUGS	WEIGHT (LB)	BOLT PART NO.	FLANGE
VR02 M4 01	EPDM	DIN	1 1/2	42	4	3.77	EW06 00 03	RX30 M4 00
VR02 M4 02	FKM	DIN	1 1/2	42	4	3.77	EW06 00 03	RX30 M4 00
VR02 M6 01	EPDM	DIN	2	60	4	4.63	EW06 00 03	RX30 M6 00
VR02 M6 02	FKM	DIN	2	60	4	4.63	EW06 00 03	RX30 M6 00
VR02 L1 01US	EPDM	ANSI	3	76	4	7.05	EW10 00 01	RX31 L1 00
VR02 L1 02US	FKM	ANSI	3	76	4	7.05	EW10 00 01	RX31 L1 00
VR02 L3 01US	EPDM	ANSI	4	101	8	9.48	EW10 00 01	RX31 L3 00
VR02 L3 02US	FKM	ANSI	4	101	8	9.48	EW10 00 01	RX31 L3 00

Models with CE marking. EW06 bolt kits are not supplied for valve/flanges assembly. The butterfly valves do not require additional ring when connected to circular flanges. Suitable for flanges according to EN 1092-1 - PN 16.

## Bolt Kit



PART NO.	THD SIZE (IN)	L (IN)	NUMBER OF BOLTS
EW06 00 03	M16	3.54	X 8
EW10 00 01	5/8"-11	1.23	X 8

## Butterfly Valve Accessories Chart

PART NO.	OD (IN)	OD (MM)	BUTTERFLY VALVE PART NO.	BOLT KIT PART NO.	NUMBER OF KITS	MAX. TIGHTENING TORQUE (FT-LBS)
RX30 M4 00	1 1/2	42	VR02 M4 01	EW06 00 03	1	36.88
RX30 M4 00	1 1/2	42	VR02 M4 02	EW06 00 03	1	36.88
RX30 M6 00	2	60	VR02 M6 01	EW06 00 03	1	36.88
RX30 M6 00	2	60	VR02 M6 02	EW06 00 03	1	36.88
RX31 L1 00	3	76	VR02 L1 01US	EW10 00 01	2	36.88
RX31 L1 00	3	76	VR02 L1 02US	EW10 00 01	2	36.88
RX31 L3 00	4	101	VR02 L3 01US	EW10 00 01	2	36.88
RX31 L3 00	4	101	VR02 L3 02US	EW10 00 01	2	36.88

**WARNING:** This product can expose you to chemicals including Lead and Lead Compounds which is known to the State of California to cause cancer and birth defects or other reproductive harm. For more information go to [www.P65Warnings.ca.gov](http://www.P65Warnings.ca.gov)



**Diameters: 1 1/2" to 4"**

**Ball Valve**

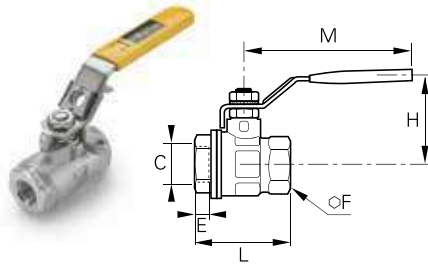

**Stainless Steel**

PART NO.	SEAL	THD SIZE (IN)	L (IN)	WEIGHT (LB)
VP502SS-4	PTFE	1/4	5.03	.59
VP502SS-8	PTFE	1/2	5.13	.67
VP502SS-12	PTFE	3/4	6.67	1.57
VP502SS-16	PTFE	1	6.77	2.09
VP502SS-24	PTFE	1 1/2	7.19	4.95
VP502SS-32	PTFE	2	9.75	10.52

\*Model with CE marking.

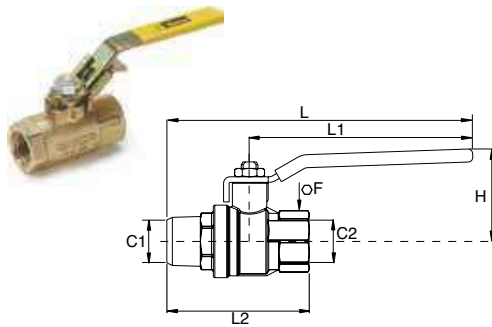

**Brass**

PART NO.	SEAL	THD SIZE (IN)	L (IN)	WEIGHT (LB)
VP500P-4	PTFE	1/4	4.90	.60
VP500P-8	PTFE	1/2	5.00	.64
VP500P-12	PTFE	3/4	5.25	.86
VP500P-16	PTFE	1	5.34	3.47
VP500P-24	PTFE	1 1/2	8.23	3.47
VP500P-32	PTFE	2	8.58	5.56

\*Model with CE marking.

# Tools

**Diameters: 3/4" to 4"**

**Pipe Cutter**

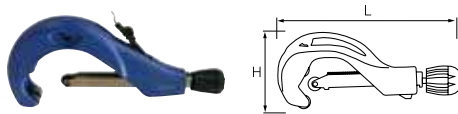

PART NO.	USED FOR TRANSAIR® PIPE (IN)
6698 03 01	Ø 3/4" to 3"
EW08 00 03	Ø 4"

■ Includes deburring tool.

**Diameters: 2"**

**Spanner Wrenches**



PART NO.
6698 05 03

Includes two tightening spanners.  
Used to tighten 50mm and 63mm connectors.

**WARNING:** This product can expose you to chemicals including Lead and Lead Compounds which is known to the State of California to cause cancer and birth defects or other reproductive harm. For more information go to [www.P65Warnings.ca.gov](http://www.P65Warnings.ca.gov)



**Diameters: 1" to 4"**

**Drilling Tool for Rigid Aluminum Pipe**

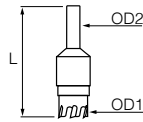

PART NO.	OD1 (IN)	OD1 (MM)	OD2 (IN)	OD2 (MM)	L (IN)	USED FOR TRANSAIR® PIPE (IN)
6698 02 02	5/8	16	1/2	11	2 7/8	Ø 1"

Drilling tool 6698 02 02 is required to install Ø 1" Transair® brackets. Recommended to be used with any cordless drill with a 1/2" chuck. Use with Transair drilling jig, 6698 01 03.

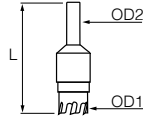

PART NO.	OD1 (IN)	OD1 (MM)	OD2 (IN)	OD2 (MM)	L (IN)	USED FOR TRANSAIR® PIPE (IN)
6698 02 01	1	22	1/2	13	2 3/4	Ø 1 1/2" - 2"

Drilling tool 6698 02 01 is required to install Ø 1 1/2" and Ø 2 1/2" Transair® brackets. Recommended to be used with any cordless drill with a 1/2" chuck.

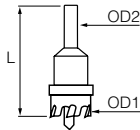

PART NO.	OD1 (IN)	OD1 (MM)	OD2 (IN)	OD2 (MM)	L (IN)	USED FOR TRANSAIR® PIPE (IN)
EW09 00 22	1	22	1/2	13	2 3/4	Ø 1 1/2" - 2"
EW09 00 30	1 3/16	30	1/2	13	2 3/4	Ø 3" - 4"

Drilling tool EW09 is required to install Transair® direct feed brackets. After drilling, it is important to deburr and clean the pipe. Recommended to be used with any cordless drill with a 1/2" chuck.

**Selection Chart**

PART NO.	OD (IN)	OD (MM)	TOOL PART NO.
RR89 M4N06 01	1 1/2	42	EW09 00 22
RR89 M6N06 01	2	60	EW09 00 22
RR89 L1N08 01	3	76	EW09 00 30
RR89 L3N08 01	4	101	EW09 00 30
RR89 M4N06 02	1 1/2	42	EW09 00 22
RR89 M6N06 02	2	60	EW09 00 22
RR89 L1N08 02	3	76	EW09 00 30
RR89 L3N08 02	4	101	EW09 00 30

**Deburring Tool**

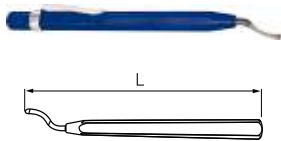

PART NO.
6698 04 02

**Portable Crimping Tool Kit**



PART NO.	VOLTAGE
EW01 00 02	14

This case contains: one portable tool, one 14V battery and battery charger. Jaws sold separately.

**Jaws for Portable Crimping Tool**

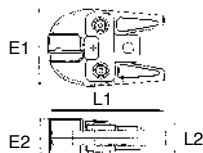

PART NO.	USED FOR TRANSAIR PIPE (IN)	USED FOR TRANSAIR PIPE (MM)
EW02 M4 00	1 1/2"	42
EW02 M6 00	2"	60
EW02 L1 00	3	76
EW02 L3 00	4	101

**WARNING:** This product can expose you to chemicals including Lead and Lead Compounds which is known to the State of California to cause cancer and birth defects or other reproductive harm. For more information go to [www.P65Warnings.ca.gov](http://www.P65Warnings.ca.gov)

**Dismounting Tool**



PART NO.	EW11 00 01
----------	------------

Contains 1 key, 5 rings for dismounting Ø22 and 5 rings for dismounting Ø28

**Maintenance Set**

PART NO.	SEAL	OD (IN)	OD (MM)
EW10 N7 01	EPDM	3/4	22
EW10 N9 01	EPDM	1	28
EW10 N7 02	FKM	3/4	22
EW10 N9 02	FKM	1	28

# Fixtures and Accessories

**Diameters: 3" to 4"      Fixing Clip for Stainless Steel Pipe**

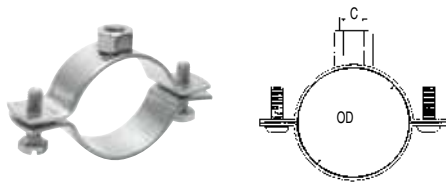

PART NO.	OD (IN)	OD (MM)	THD SIZE (IN)
EX01 L1 00	3	76	3/8"-16
EX01 L3 00	4	101	3/8"-16

Maximum admitted static load: 200 daN

**Diameters: 1/2" to 4"      Fixing Clip for Stainless Steel Pipe**

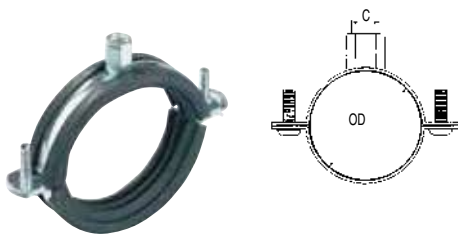

PART NO.	OD (IN)	OD (MM)	THD SIZE (IN)
ER01 N7 01	3/4	22	3/8"-16
ER01 N9 01	1	28	3/8"-16
ER01 M4 01	1 1/2	42	3/8"-16
ER01 M6 01	2	60	3/8"-16
ER01 L1 00	3	76	3/8"-16
ER01 L3 00	4	101	3/8"-16

Maximum admitted static load: 210 daN

**WARNING:** This product can expose you to chemicals including Lead and Lead Compounds which is known to the State of California to cause cancer and birth defects or other reproductive harm. For more information go to [www.P65Warnings.ca.gov](http://www.P65Warnings.ca.gov)

# The Golden Rules of Installation

## Installation Instructions

### General

When maintaining or modifying a Transair® system, the relevant section should be purged prior to the commencement of any work.

Installers should only use Transair® components and accessories, in particular Transair® pipe clips and fixture clamps. The technical properties of the Transair® components, as described in the Transair® catalog, must be respected.

### Commissioning the Installation

Once the Transair® system has been installed and prior to commissioning, the installer should complete all tests, inspections and compliance checks as stated in any contract and according to sound engineering practice and current local regulations.

### Component Assembly

Transair® components are provided with assembly instructions for their correct use - simply follow the methods and recommendations stated in this document or separate data sheets.

### Transair® Installations - Prohibited Situations

- Installation within a solid mass (concrete, foam, etc.), especially underground
- The suspension of any external equipment from Transair® pipe
- The use of Transair® for earthing, or as a support for electrical equipment
- Exposure to chemicals that are incompatible with Transair® components (please contact us for further details).
- Use of components not approved by Transair®



**WARNING:** This product can expose you to chemicals including Lead and Lead Compounds which is known to the State of California to cause cancer and birth defects or other reproductive harm. For more information go to [www.P65Warnings.ca.gov](http://www.P65Warnings.ca.gov)



## Best Practices

**When installing a Transair® system, work should be performed in accordance with good engineering practice.**

**Bends and bypasses represent sources of pressure drops.**

**Keep in-line pipe diameter reductions to a minimum.**

**The diameter of the pipe will influence pressure drop and the operation of point-of-use equipment.**

**Select the diameter according to the required flow rate and acceptable pressure drop at the point of use.**

**Never encase the network in a hard solid mass, in order to facilitate maintenance or servicing.**

**To insulate Transair® industrial water systems thermally, we recommend insulating the Transair® stainless steel pipes.**

**Position drops and feeds to take-off points as close as possible to the point of use.**



**WARNING:** This product can expose you to chemicals including Lead and Lead Compounds which is known to the State of California to cause cancer and birth defects or other reproductive harm. For more information go to [www.P65Warnings.ca.gov](http://www.P65Warnings.ca.gov)



# Transair® Stainless Steel Pipe

## General

### Presentation

Transair® stainless steel pipe is supplied “ready for use”. No particular preparation (cutting, deburring, chamfering, etc.) is required. Thanks to the rigidity of Transair® stainless steel pipe, temperature-related expansion / contraction phenomena are reduced to a minimum. The Transair® network retains its straightness, and hence its performance, over time (reduction of pressure drop caused by surface friction). Transair® stainless steel pipe is calibrated and fits perfectly onto all Transair® components. Each connection is automatically secured and sealing is, thus, optimized. The use of Transair® stainless steel



STANDARDS	22 to 28 MM	42 to 60 MM	76 to 101 MM
MANUFACTURING STANDARDS	EN 10217-7	EN 10217-7	EN 10217-7
GRADE	EN 10088-2, 1.4404 / AISI 316 L	1.4301 / AISI 304	1.4301 / AISI 304
WELDING STANDARDS	DIN 17 457, EN 10217-7	DIN 17 457, EN 10217-7	DIN 17 457, EN 10217-7
TOLERANCES	DVGW - W541	EN 1127 D4 / T3	EN 1127 D4 / T3

				VALUE FOR 1 METRE OF PIPE					
Ø EXT		Ø INT		VOLUME (L)		PIPE MASS (KG)		MASS OF THE NETWORK FULL OF WATER	
(IN)	(MM)	(IN)	(MM)	(G)	(L)	(LB)	(KG)	(LB)	(KG)
.87	22.0	.77	19.6	.07	.30	1.38	.627	2.04	.929
1.10	28.0	1	25.6	.13	.51	1.78	.808	2.91	1.323
1.67	42.3	1.53	39.1	.31	1.20	3.56	1.616	6.21	2.817
2.37	60.3	2.24	57.1	.67	2.56	5.13	2.331	10.78	4.892
3	76.1	2.87	72.9	1.10	4.17	6.52	2.958	15.72	7.132
4	101.6	3.84	97.6	1.97	7.48	10.89	4.944	27.39	12.425

**WARNING:** This product can expose you to chemicals including Lead and Lead Compounds which is known to the State of California to cause cancer and birth defects or other reproductive harm. For more information go to [www.P65Warnings.ca.gov](http://www.P65Warnings.ca.gov)

# Pipe Section

22 to 28 mm

## Tools



**Pipe-Cutter**  
6698 03 01



**Chamfering Tool**  
6698 04 01



**Deburring Tool**  
6698 04 02



**Marker Pen**

## Procedure

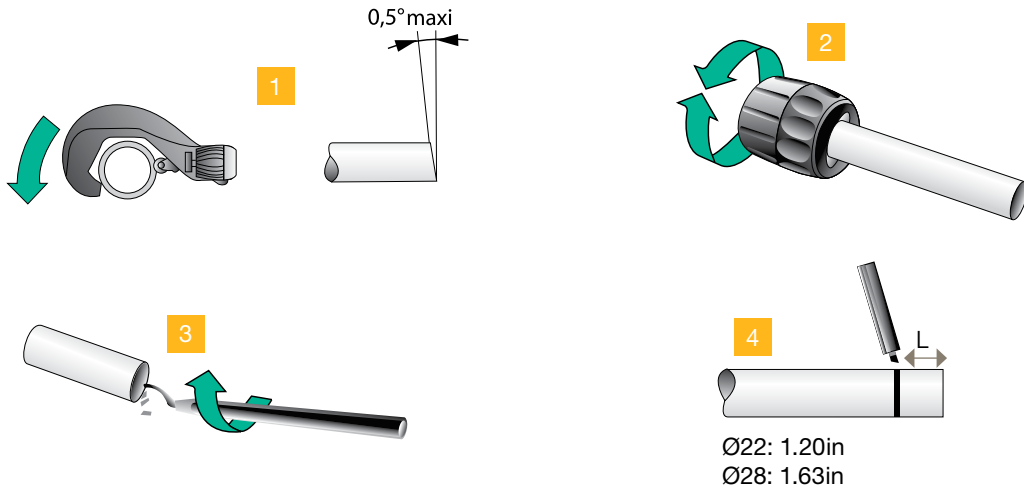

1. Cutting the pipe:

- place the pipe into the pipe cutter
- position the blade onto the pipe
- rotate the pipe cutter around the pipe while gently tightening the wheel.

2. Carefully chamfer the outer edges

- 3. Also deburr the interior end of the pipe
- 4. Mark the connection indicator.

**WARNING:** This product can expose you to chemicals including Lead and Lead Compounds which is known to the State of California to cause cancer and birth defects or other reproductive harm. For more information go to [www.P65Warnings.ca.gov](http://www.P65Warnings.ca.gov)



# Pipe Section

42 to 101 mm



**Pipe-Cutter**

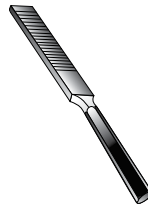

**File**



**Deburring Tool**



**Portable Tool Kit Ref.**  
Ew01 00 01 (220V) Or  
Ew01 00 03 (110V)



**Pipe Forming Jaw Set Ref.**  
EW02 M4 00 (Ø 42)      EW02 L1 00 (Ø 76)  
EW02 M6 00 (Ø 60)      EW02 L3 00 (Ø 101)

## Procedure

### 1 - PIPE SECTION

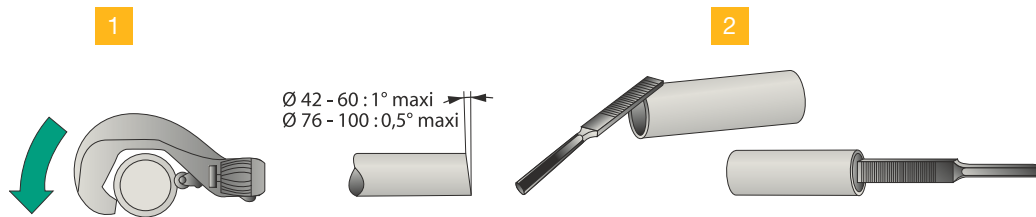

**1. Cutting the pipe:**

- place the pipe into the pipe cutter
- position the blade onto the pipe
- rotate the pipe cutter around the pipe while gently tightening the wheel

**2. Carefully chamfer and deburr the end of the pipe with a file.**

**WARNING:** This product can expose you to chemicals including Lead and Lead Compounds which is known to the State of California to cause cancer and birth defects or other reproductive harm. For more information go to [www.P65Warnings.ca.gov](http://www.P65Warnings.ca.gov)



## 2 - PREPARATION OF THE PORTABLE TOOL KIT



Open the retaining pin at the front of the machine by pressing the jaw to release button\*.



Place the jaws in the housing.



Lock in position by closing the retaining pin.

## 3 - HOW TO CREATE THE LUGS



Manually open the jaws of the clamp and insert the stainless steel pipe into the clamp as far as it will go.





Release the jaws. Press the trigger and crimp the tube until a 'snap' sound is heard.



Re-open the two jaws to remove the pipe and rotate the pipe slightly.

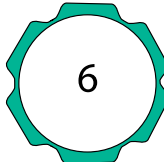
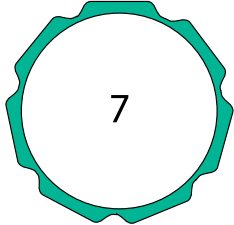

Renew the operation until the required minimum number of lugs for each diameter is achieved

	42MM	60MM	76MM	101 MM
MINIMUM NUMBER OF LUGS	 4	 4	 6	 7

Important: DO NOT OVERLAP THE LUGS!

**WARNING:** This product can expose you to chemicals including Lead and Lead Compounds which is known to the State of California to cause cancer and birth defects or other reproductive harm. For more information go to [www.P65Warnings.ca.gov](http://www.P65Warnings.ca.gov)

# Transair® Connectors

## 22 - 28mm Instant Connection by Means of a Gripping Ring

Pipe-to-pipe and stud connectors in Ø22 and Ø28 can be immediately connected to Transair® stainless steel pipe – simply push the pipe into the connector up to the connection mark. The gripping ring of each fitting is then automatically secured and the connection is safe.

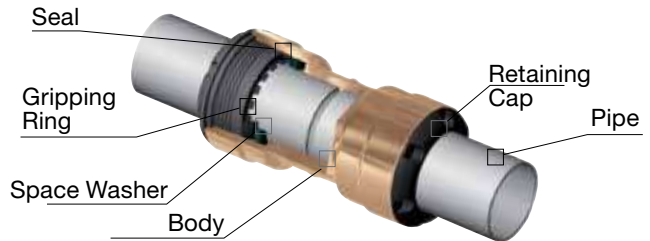

## 42 to 60mm Double-Clamp Quick-Fit Connection

Pipe-to-pipe and stud connectors in Ø42 and Ø60 can be quickly connected to Transair® stainless steel pipe by means of a double clamp ring. This secures the connection between the nut and the pipe – tightening of the nuts secures the final assembly.



## 76 to 101mm Clamp Quick-Fit Connection

Pipe-to-pipe and stud connectors in Ø76 and Ø101 can be quickly connected to Transair® stainless steel pipe. Position the pipes to be connected within the Transair® cartridge and close/tighten the Transair® clamp.

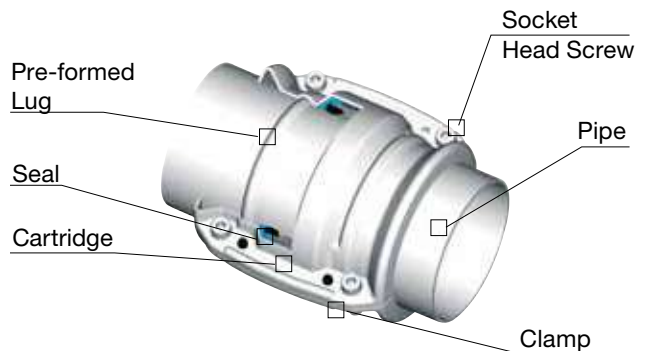

**WARNING:** This product can expose you to chemicals including Lead and Lead Compounds which is known to the State of California to cause cancer and birth defects or other reproductive harm. For more information go to [www.P65Warnings.ca.gov](http://www.P65Warnings.ca.gov)

# Connection / Disconnection

22 to 28 mm

## Tools



Dismounting Tool  
EW11 00 01

## Procedure

### Connection

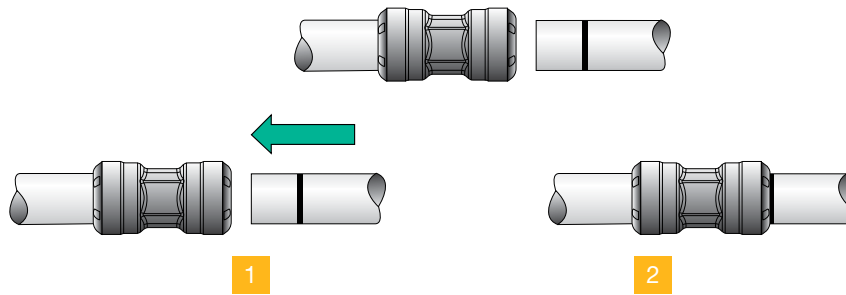

### Disconnection

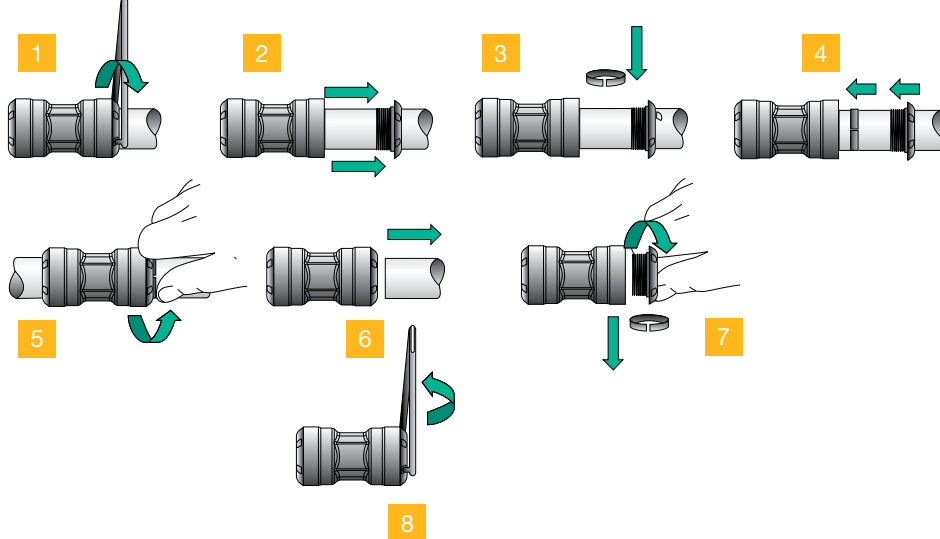

**WARNING:** This product can expose you to chemicals including Lead and Lead Compounds which is known to the State of California to cause cancer and birth defects or other reproductive harm. For more information go to [www.P65Warnings.ca.gov](http://www.P65Warnings.ca.gov)



## 42 to 60 mm

### Connection/Disconnection

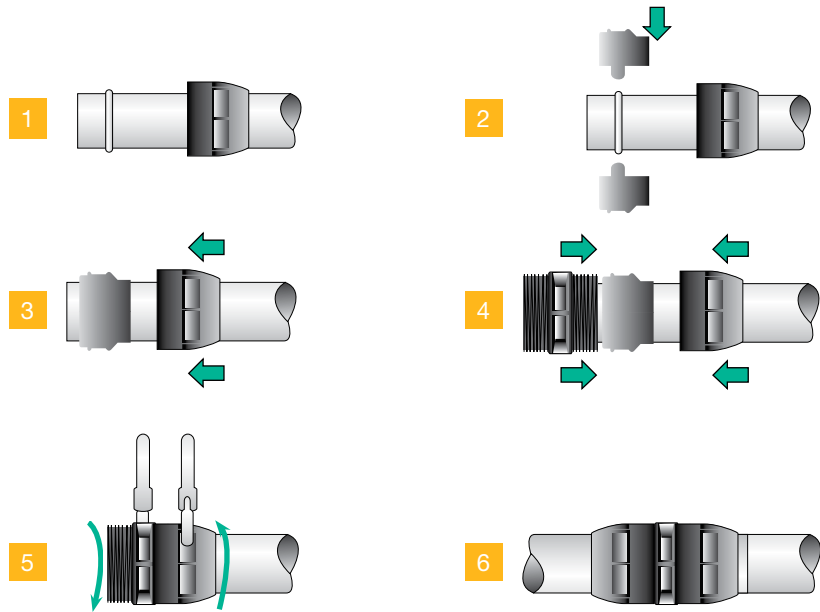

### Lateral Mounting

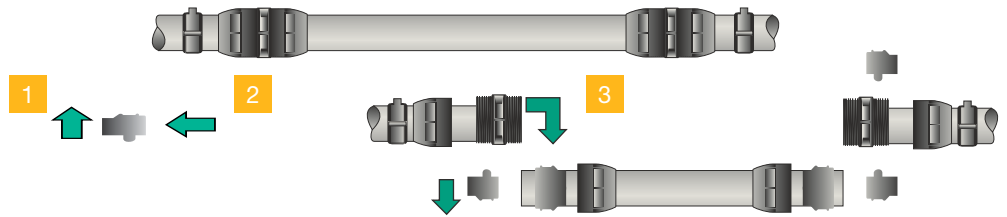

#### Replace 1 Connector by a Tee

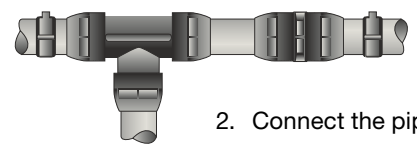
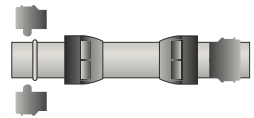
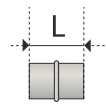

Ø	L (IN)
42	4.13
60	4.84

1. Cut the pipe and create the lugs (cf pages 141)

2. Connect the pipe

#### Add 1 Tee

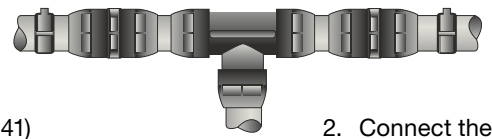
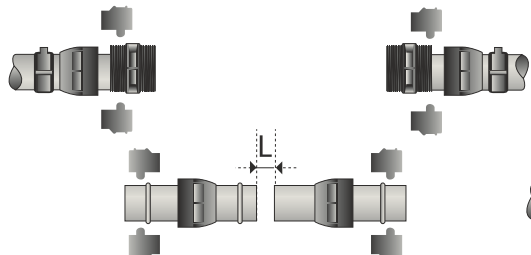

Ø	L (IN)
42	2.36
60	4.33

1. Cut the pipe and create the lugs (cf pages 141)

2. Connect the pipe

**WARNING:** This product can expose you to chemicals including Lead and Lead Compounds which is known to the State of California to cause cancer and birth defects or other reproductive harm. For more information go to [www.P65Warnings.ca.gov](http://www.P65Warnings.ca.gov)

## 76 to 101 mm

### Connection/Disconnection

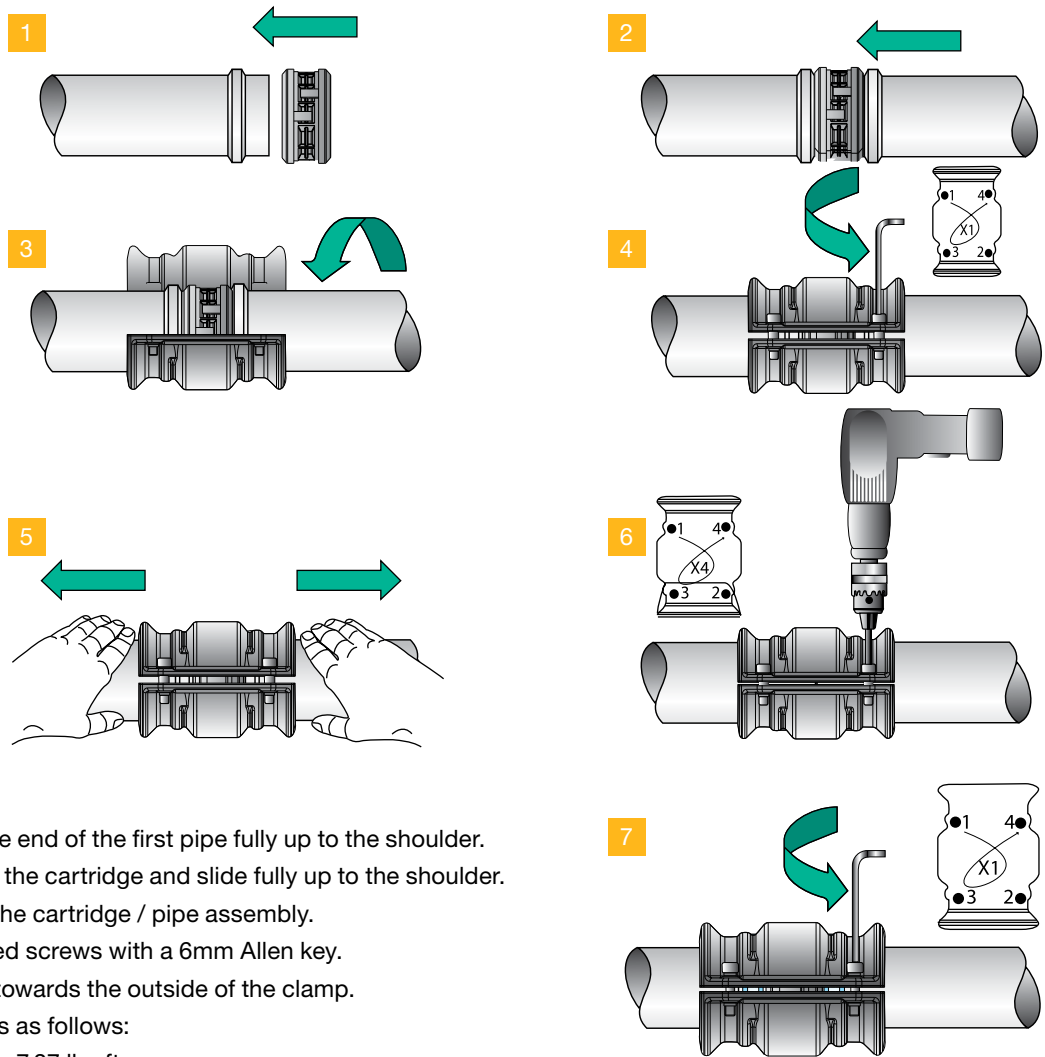

1. Slip the cartridge over the end of the first pipe fully up to the shoulder.
2. Bring the second pipe to the cartridge and slide fully up to the shoulder.
3. Position the clamp over the cartridge / pipe assembly.
4. Hand tighten the pre-fitted screws with a 6mm Allen key.
5. Pull the pipes fully back towards the outside of the clamp.
6. Tighten the clamp screws as follows:
  - mini tightening torque: 7.37 lbs ft
  - maxi tightening torque: make the 2 clamps touch together
7. For effective clamp sealing, screw tightening should be performed on alternate sides of the clamp as shown above.

For effective clamp sealing, screw tightening should be performed on alternate sides of the clamp as shown below:

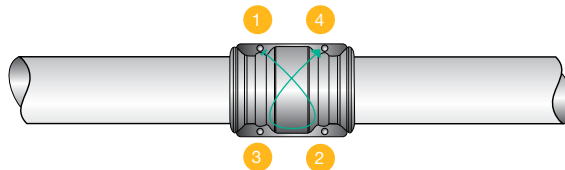

To disconnect, perform the same operations in reverse order.

**WARNING:** This product can expose you to chemicals including Lead and Lead Compounds which is known to the State of California to cause cancer and birth defects or other reproductive harm. For more information go to [www.P65Warnings.ca.gov](http://www.P65Warnings.ca.gov)

# Practical Examples

Various Ø76 and Ø101 configurations

Changing direction with a 90° elbow

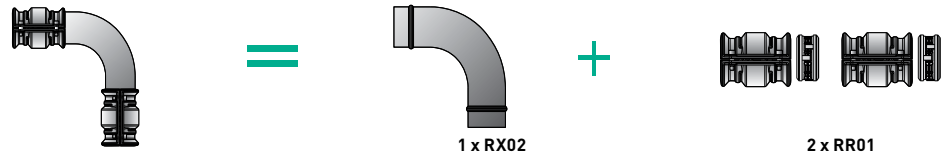

Changing direction with a tee piece

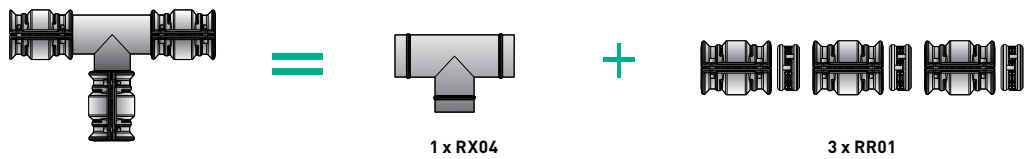

Connecting an end cap

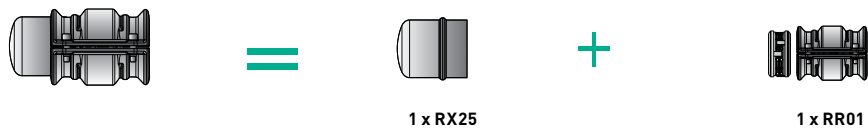

Connecting a circular flange and a connector

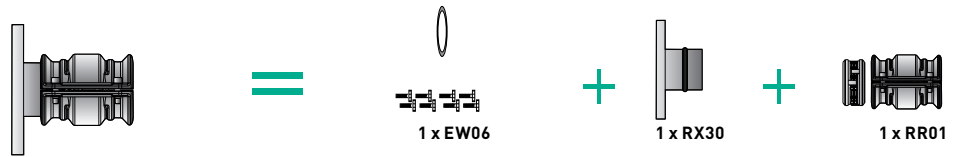

Reduction



Connecting a butterfly valve

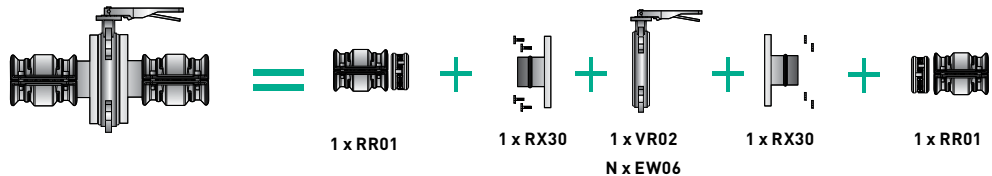

**WARNING:** This product can expose you to chemicals including Lead and Lead Compounds which is known to the State of California to cause cancer and birth defects or other reproductive harm. For more information go to [www.P65Warnings.ca.gov](http://www.P65Warnings.ca.gov)

# Fixtures and Accessories

22 to 101 mm

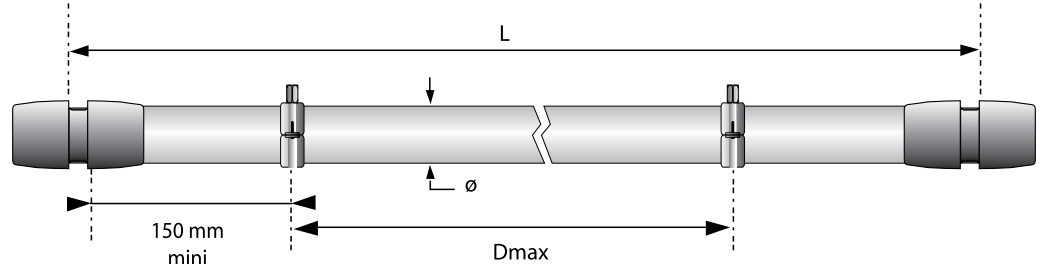

**L = 20ft**

∅	DMAX (FT)
22	9.8
28	9.8
42	13.12
60	13.12
76	16.40
101	16.40

It is recommended that all hanging / support calculations be done prior to installing and determining fixture installation configuration.  
CHECK WITH ENGINEERING

**WARNING:** This product can expose you to chemicals including Lead and Lead Compounds which is known to the State of California to cause cancer and birth defects or other reproductive harm. For more information go to [www.P65Warnings.ca.gov](http://www.P65Warnings.ca.gov)



# Transair® Quick Assembly Brackets

## Fitting a Bracket

### 42 to 101 mm Pipe

#### Tools Required



**Drilling Tool For Transair®  
Stainless Steel Pipe**  
EW09 00 22  
EW09 00 30



**Deburring Tool For Transair®  
Stainless Steel Pipe**  
6698 04 02

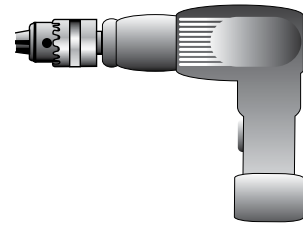

**Drill**

#### Procedure

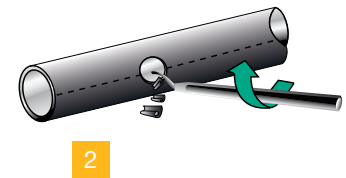
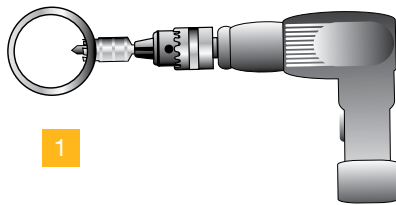

1. Drill the Transair® stainless steel pipe at the desired position using following drilling tools:
  - Ø42 - Ø60: drilling tool EW09 00 22
  - Ø76 - Ø101: drilling tool EW09 00 30
2. Carefully deburr the pipe.
3. Position the bracket and tighten the 2 screws.

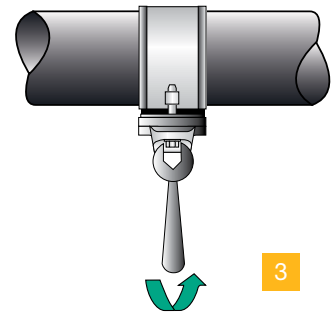

**WARNING:** This product can expose you to chemicals including Lead and Lead Compounds which is known to the State of California to cause cancer and birth defects or other reproductive harm. For more information go to [www.P65Warnings.ca.gov](http://www.P65Warnings.ca.gov)



# Bending a Transair® Stainless Steel Pipe

## All Diameters

Thanks to their technical characteristics, Transair® stainless steel pipe can be bent according to the following specifications:

PART NO.	R MIN. (IN)	L MIN. (IN)
Ø 22	1.73	4.92
Ø 28	2.20	4.92
Ø 42	3.30	4.92
Ø 60	3.66	4.92
Ø 76	4.48	4.92
Ø 101	5.98	4.92

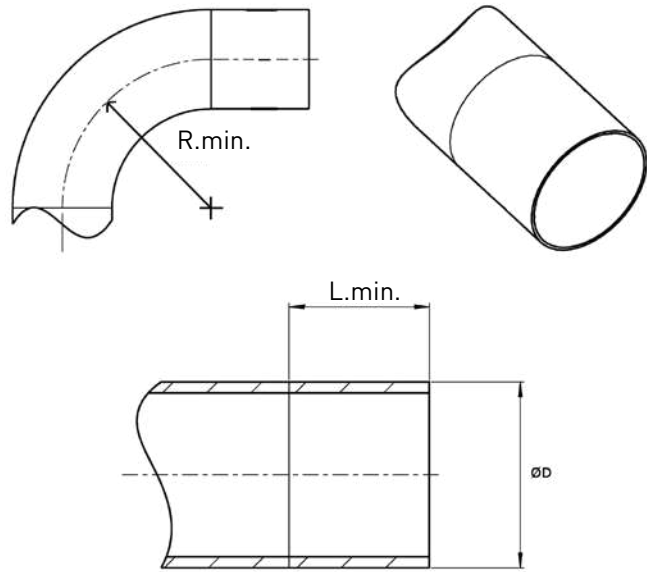

**WARNING:** This product can expose you to chemicals including Lead and Lead Compounds which is known to the State of California to cause cancer and birth defects or other reproductive harm. For more information go to [www.P65Warnings.ca.gov](http://www.P65Warnings.ca.gov)

## PRACTICAL INFORMATION

### Z Dimensions

RP02/RR02	Z (IN)	Z (MM)
Ø 22	.51	13
Ø 28	.59	15

RP02	Z (IN)	Z (MM)
Ø 42	2.17	55
Ø 60	2.52	64

RR02 N7 - RR02 N9

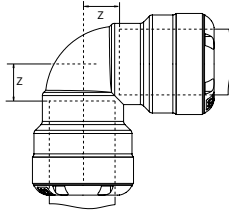

RP02 M4 - RP02 M6

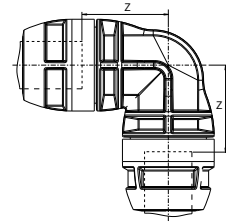

RR06	Z (IN)	Z (MM)
Ø 22	.05	1.2
Ø 28	.05	1.2
Ø 22 -> Ø 28	.06	1.6

RR04	Z (IN)	Z (MM)
Ø 42	.10	2.6
Ø 60	.10	2.6

RR06 N7 - RR06 N9

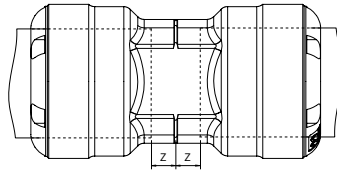

RP06 M4 - RP06 M6

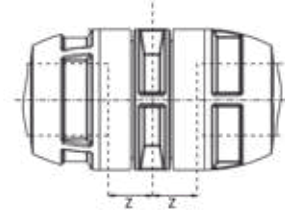

RR04	Z1 (IN)	Z1 (MM)	Z1 (IN)	Z2 (MM)
Ø 42	2.17	55	2.17	55
Ø 60	2.52	64	2.52	64

RP04

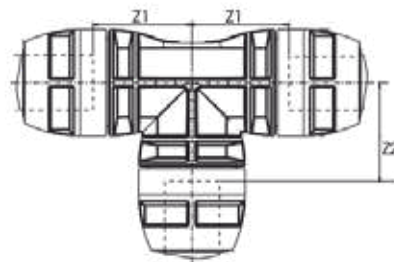

RR04	Z1 (IN)	Z1 (MM)	Z1 (IN)	Z2 (MM)
Ø 22	.46	11.7	.43	11
Ø 28	.59	15	.59	15
Ø 28 -> Ø 22	.63	12	.63	16

RR04 N9 N7

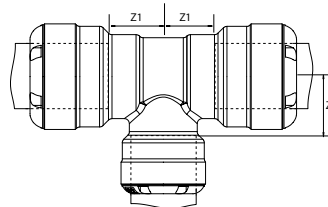

RR04 N7 - RR04 N9

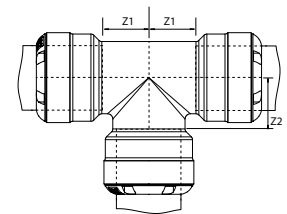

**WARNING:** This product can expose you to chemicals including Lead and Lead Compounds which is known to the State of California to cause cancer and birth defects or other reproductive harm. For more information go to [www.P65Warnings.ca.gov](http://www.P65Warnings.ca.gov)

RX04	Z1 (IN)	Z1 (MM)	Z1 (IN)	Z2 (MM)
Ø 76	5.75	146	5.75	146
Ø 76 -> Ø 42	5.75	146	7.17	182
Ø 76 -> Ø 60	5.75	146	7.20	183
Ø 101	6.14	156	5.35	136
Ø 101 -> Ø 42	6.14	156	7.72	196
Ø 101 -> Ø 60	6.14	156	7.72	196
Ø 101 -> Ø 76	6.14	156	5.35	136

RX04 L1 00 - RX04 L3 00

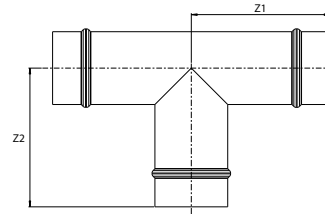

RX02	Z (IN)	Z (MM)
Ø 76	7.44	189
Ø 101	8.94	227

RX02 L1 00 - RX02 L3 00

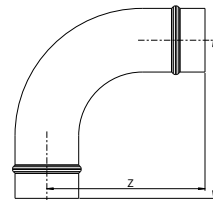

RR05	Z (IN)	Z (MM)
RR05 N7 04	.83	21
RR05 N7 06	.87	22
RR05 N9 08	.94	24

RR05 N7 04 - RR05 N7 06  
RR05 N9 08

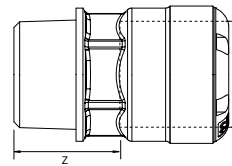

RR23/RX23	Z1 (MM)	Z1 (MM)	Z1 (MM)	Z2 (MM)
Ø 22	.47	12	.55	14
Ø 76	5.75	146	2.48	63
Ø 101	6.14	156	2.99	76

RR23 N7 06

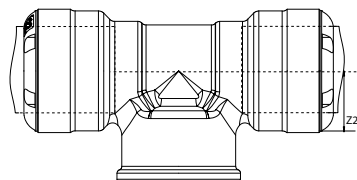

RX23 L1 04 - RX23 L3 04

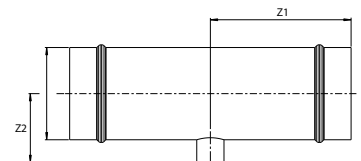

**WARNING:** This product can expose you to chemicals including Lead and Lead Compounds which is known to the State of California to cause cancer and birth defects or other reproductive harm. For more information go to [www.P65Warnings.ca.gov](http://www.P65Warnings.ca.gov)

To meet the requirements of compressed air and vacuum applications in harsh environments (food and beverage, pharmaceutical or laboratories), Transair® now proposes a complete range of Ø22 mm 316L stainless steel drops,

These modular drops with instant connection technology are very easy to clean and are resistant to aggressive chemical agents (list of chemical compatibility available upon request).

For food and beverage applications, these drops can be used in food or splash zones as they are compatible with

### Technical Specifications

- Pipe external diameter: 22 mm
- Pipe internal diameter: 19.6 mm
- Full bore design
- Push-in technology
- Material (fitting and pipe): full stainless steel 316L
- Fittings individually packed in a plastic bag
- Sealing: FKM
- Pressure: 0 to 10 bar
- Temperature: - 20°C to + 120°C
- Vacuum: 10 mbar (absolute value)

### Advantages and Benefits

- Fully dismountable and reusable
- Instant connection and disconnection
- Modular and flexible networks
- Optimisation of cleaning and maintenance operations
- Large chemical compatibility for applications in aggressive chemical environments (See Chemical Compatibility Chart page 115)
- The 3-port wall bracket facilitates the connection to the process.

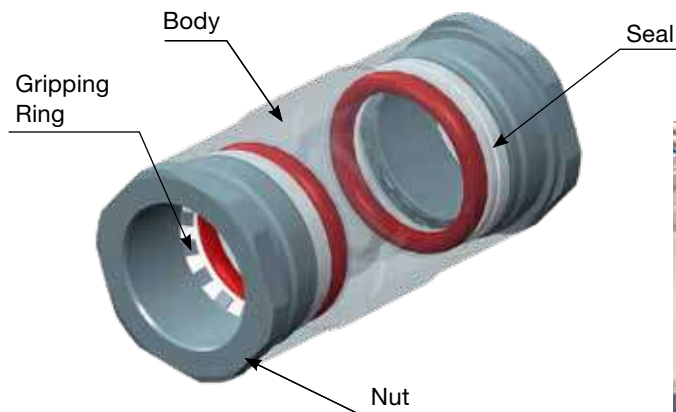

Example of an application in the Food & Beverage Industry: the user needed a full stainless steel 22mm drop in a wash down zone.



**WARNING:** This product can expose you to chemicals including Lead and Lead Compounds which is known to the State of California to cause cancer and birth defects or other reproductive harm. For more information go to [www.P65Warnings.ca.gov](http://www.P65Warnings.ca.gov)

## Instructions for Assembly and Disassembly of a Stainless Steel Drop



Assembly: simply push the pipe into the fitting.



Disassembly: 1. Manually unscrew the nut and slide the nut along the pipe.



Disassembly : 2. Put the red dismounting ring on the pipe and re-screw the nut on the fitting.



Disassembly : 3. Pull the pipe from the fitting.













Disassembly : 4. Manually unscrew the nut and remove the red dismounting ring.



Disassembly : 5. Re-screw the nut on the fitting without the red ring; it is ready for assembly.

These drops can be connected to quick assembly brackets of Transair® aluminium range (pages 40/41 in this catalog) and to quick assembly brackets of Transair® stainless steel range (page 129).

PART NO.	DESCRIPTION
 TF16 N7 00	3/4" (22MM) 316L STAINLESS STEEL PIPE (LENGTH: 20')
 RF06 N7 02	3/4" (22MM) 316L STAINLESS STEEL UNION CONNECTOR W/ FKM SEAL
 RF02 N7 00	3/4" (22MM) 316L STAINLESS STEEL 90° BENT PIPE ELBOW
 RF02 N7 02	3/4" (22MM) 316L STAINLESS STEEL 90° ELBOW W/ FKM SEAL
 RF04 06 00	3/4" (22MM) 316L STAINLESS STEEL FEMALE THREADED 3/4" NPT TEE W/ FKM SEAL
 RF05 N7N06	3/4" (22MM) 316L STAINLESS STEEL MALE THREADED 3/4" NPT ADAPTER
 RF36 06N04	3/4" (22MM) 316L STAINLESS STEEL 3 PORT 3/4" NPT WALL BRACKET (PLUGS NOT INCLUDED)
 EF27 00N04	3/4" (22MM) 316L STAINLESS STEEL NPT PLUG W/ FKM SEAL
 VP502SS-12	3/4" (22MM) 316L STAINLESS STEEL 3/4" NPT FEMALE TO FEMALE LOCKABLE BALL VALVE
 EX01 N7 01	3/4" (22MM) STAINLESS STEEL FIXING CLIP
 EW11 N7 00	3/4" (22MM) DISMOUNTING RING

**WARNING:** This product can expose you to chemicals including Lead and Lead Compounds which is known to the State of California to cause cancer and birth defects or other reproductive harm. For more information go to [www.P65Warnings.ca.gov](http://www.P65Warnings.ca.gov)

# Numerical Index

0169 00 05 00.....	C5	6604 50 00.....	A11	6611 50 50.....	A16
1001E25 00 01 .....	A7	6604 50 25.....	A12	6611 63 41.....	A16
1001E25 00 03 .....	A7	6604 50 40.....	A12	6611 63 44.....	A16
1001E25 00 04 .....	A7	6604 63 00.....	A11	6612 25 00.....	A10
1001E40 00 02 .....	A7	6604 63 40.....	A12	6612 40 00.....	A10
1001E40 00 04 .....	A7	6604 63 50.....	A12	6612 50 00.....	A10
1001E40 00 05 .....	A7	6605 17 14.....	A15	6612 63 00.....	A10
1001E50 00 04 .....	A7	6605 17 22.....	A15	6615 25 22.....	A16
1001E50 00 09 .....	A7	6605 25 22.....	A15	6615 25 28.....	A16
1001E63 00 05 .....	A7	6605 25 28.....	A15	6615 25 35.....	A16
1001E63 00 06 .....	A7	6605 25 35.....	A15	6615 40 43.....	A16
1001E63 00 08 .....	A7	6605 40 35.....	A15	6615 40 50.....	A16
1013A17 04 00 .....	A4	6605 40 43.....	A15	6615 50 44.....	A16
1013A17 06 00 .....	A5	6605 40 44.....	A15	6615 50 50.....	A16
1013A25 04 00 .....	A4	6605 40 50.....	A15	6619 25 22.....	A11
1013A40 04 00 .....	A4	6605 50 44.....	A16	6619 25 28.....	A11
1013A50 04 .....	A4	6605 50 50.....	A16	6619 25 35.....	A11
1013A63 04 .....	A4	6605 63 41.....	A16	6619 40 35.....	A11
1014A17 02 .....	A5	6605 63 44.....	A16	6619 40 43.....	A11
1014A17 04 .....	A4	6605 63 46.....	A16	6619 40 44.....	A11
1016A25 02 00 .....	A5	6606 17 00.....	A8	6619 40 50.....	A11
1016A25 04 00 .....	A4	6606 25 00.....	A8	6619 50 44.....	A11
1016A25 06 00 .....	A5	6606 40 00.....	A8	6619 50 50.....	A11
1016A40 02 00 .....	A5	6606 50 00.....	A8	6619 63 44.....	A11
1016A40 04 00 .....	A4	6606 63 00.....	A8	6621 17 22.....	A16
1016A40 06 00 .....	A5	6609 17 14.....	A10	6621 25 22.....	A16
1016A50 02 .....	A5	6609 17 22.....	A10	6621 25 28.....	A16
1016A50 04 .....	A4	6609 25 22.....	A10	6621 25 35.....	A16
1016A50 06 .....	A5	6609 25 28.....	A10	6621 40 43.....	A16
1016A63 02 .....	A5	6609 25 35.....	A10	6621 40 50.....	A16
1016A63 04 .....	A4	6609 40 35.....	A10	6625 17 00.....	A15
1016A63 06 .....	A5	6609 40 43.....	A10	6625 25 00.....	A15
4092 17 00.....	A25	6609 40 44.....	A10	6625 40 00.....	A15
4092 25 00.....	A25	6609 40 50.....	A10	6625 50 00.....	A15
4092 40 00.....	A25	6609 50 44.....	A10	6625 63 00.....	A15
4092 50 00.....	A25	6609 50 50.....	A10	6636 28 22.....	A24, E17
4092 63 00.....	A25	6609 63 41.....	A10	6638 25 22.....	A24
4230 00 40.....	A26	6609 63 46.....	A10	6640 17 22.....	A23
4299 03 01.....	A26	6611 17 22.....	A16	6640 25 22.....	A23
6602 17 00.....	A9	6611 25 22.....	A16	6642 22 22.....	A23, E17
6602 25 00.....	A9	6611 25 28.....	A16	6650 00 00 04.....	A8, B5
6602 40 00.....	A9	6611 25 35.....	A16	6650 00 00 16.....	A8, B5
6602 50 00.....	A9	6611 40 35.....	A16	6651 25 12 04.....	A17
6602 63 00.....	A9	6611 40 43.....	A16	6651 40 12 04.....	A17
6604 17 00.....	A11	6611 40 44.....	A16	6653 25 22 06.....	A17
6604 25 00.....	A11	6611 40 50.....	A16	6653 40 22 06.....	A17
6604 40 00.....	A11	6611 50 44.....	A16	6662 25 00.....	A20, A21, B5

6662 25 17.....	A20, A21, B5	6698 02 02.....	B5, E20	CP15 U2N04 .....	C7
6662 40 17.....	A20, A21, B5	6698 03 01.....	B4, E19	CP21 A1 06 .....	C7
6662 40 25.....	A20, A21, B5	6698 04 01.....	B5	CP21 A1 08 .....	C7
6662 50 25.....	A21, A20	6698 04 02.....	B5, E20	CP21 A1 10 .....	C7
6662 63 25.....	A21, A20	6698 04 03.....	B6	CP21 U1 06.....	C7
6663 25 22.....	A20, A21, B5	6698 05 03.....	B6, E19	CP21 U1 08.....	C7
6663 40 22.....	A20, A21, B5	6698 11 11.....	C6	CP21 U1 10.....	C7
6663 50 22.....	A21, A21	6698 11 12.....	C6	CP21 U2 08.....	C7
6663 50 28.....	A21, A21	6698 99 03.....	A7	CP21 U2 10.....	C7
6663 63 22.....	A21, A21	9083 22 14.....	C8	CP21 U2 13.....	C7
6663 63 28.....	A21, A21	9083 22 18.....	C8	EA98 06 00.....	A22, B6
6666 17 25.....	A14	9083 23 14.....	C8	EA98 25 04.....	A22
6666 25 40.....	A14	9083 23 18.....	C8	EA98 40 04.....	A22
6666 25 50.....	A14	9083 30 14.....	C8	EA98 50 04.....	A22
6666 40 50.....	A14	9083 30 18.....	C8	EA98 63 04.....	A22
6666 40 63.....	A14	9084 22 14.....	C8	ER01 L1 00.....	C4, E21
6666 50 63.....	A14	9084 22 18.....	C8	ER01 L3 00.....	C4, E21
6668 25 22.....	A21, B5	9084 23 14.....	C8	ER01 L8 00.....	C4
6668 40 22.....	A21, B5	9084 23 18.....	C8	ER01 M4 01.....	E21
6668 50 22.....	A21, B5	9084 30 14.....	C8	ER01 M6 01.....	E21
6668 63 22.....	A21, B5	9084 30 18.....	C8	ER01 N7 01.....	E21
6668 63 28.....	A21, B5	9085 23 08.....	C8	ER01 N9 01.....	E21
6676 25 00.....	A8	9085 23 56.....	C8	EW01 00 02.....	B6, E20
6676 40 00.....	A8	9085 23 60.....	C8	EW02 L1 00.....	B6, E20
6676 50 00.....	A8	9085 30 08.....	C8	EW02 L3 00.....	B6, E20
6676 63 00.....	A8	9085 30 60.....	C8	EW02 L8 00.....	B6
6679 17 22.....	A24	9085 30 62.....	C8	EW02 M4 00.....	E20
6679 25 22.....	A24	CA-WHT-L**.....	A6	EW02 M6 00.....	E20
6684 17 22.....	A23	CA-WHT-M**.....	A6	EW03 00 01.....	B6
6684 25 22.....	A23	CA-WHT-S**.....	A6	EW04 00 01.....	A9
6688 22 22.....	A24, E17	CP05 A1N02.....	C7	EW05 63 00.....	A18
6689 17 22.....	A23	CP05 A1N03.....	C7	EW05 L1 00.....	A18
6689 25 22.....	A23	CP05 A1N04.....	C7	EW05 L1 01.....	E16
6691 22 22.....	A23, E17	CP05 U1N02.....	C7	EW05 L3 00.....	A18
6694 17 22.....	A24	CP05 U1N03.....	C7	EW05 L3 01.....	E16
6694 25 22.....	A24	CP05 U1N04.....	C7	EW05 L8 00.....	A18
6696 25 22.....	A24	CP05 U2N02.....	C7	EW05 M4 01.....	E16
6697 00 03.....	C5	CP05 U2N03.....	C7	EW05 M6 01.....	E16
6697 17 01.....	C4	CP05 U2N04.....	C7	EW06 00 01.....	A18
6697 25 01.....	C4	CP15 A1N02.....	C7	EW06 00 03.....	E16, E18
6697 40 01.....	C4	CP15 A1N03.....	C7	EW06 00 10.....	A18
6697 50 01.....	C4	CP15 A1N04.....	C7	EW06 00 11.....	A18
6697 63 01.....	C4	CP15 U1N02.....	C7	EW06 00 12.....	A18
6698 00 03.....	B4	CP15 U1N03.....	C7	EW08 00 03.....	B4, E19
6698 00 05.....	B4	CP15 U1N04.....	C7	EW08 00 04.....	B4
6698 01 03.....	B4	CP15 U2N02.....	C7	EW08 00 99.....	B4
6698 02 01.....	B5, E20	CP15 U2N03.....	C7	EW08 L1 00.....	A26

EW08 L3 01 .....	A26	RA26 63 00.....	A13	RP06 M6 01.....	E11
EW08 L8 00 .....	A26	RA26 L1 00.....	A13	RP06 M6 02.....	E11
EW09 00 22 .....	B5, E20	RA26 L1 40.....	A13	RR01 L1 00.....	A9
EW09 00 30 .....	B5, E20	RA26 L1 50.....	A13	RR01 L1 01.....	E11
EW09 00 51 .....	B5	RA26 L1 63.....	A13	RR01 L1 02.....	E11
EW09 00 64 .....	B5	RA26 L3 00.....	A13	RR01 L3 00.....	A9
EW10 00 01 .....	A26, E16, E18	RA26 L3 63.....	A13	RR01 L3 01.....	E11
EW10 00 02 .....	A26	RA26 L3 L1.....	A13	RR01 L3 02.....	E11
EW10 00 US .....	A26	RA26 L8 00.....	A13	RR01 L8 00.....	A9
EW10 N7 01 .....	E21	RA26 L8 L3.....	A13	RR02 N7 01 .....	E11
EW10 N7 02 .....	E21	RA30 63 00.....	A17, A18	RR02 N7 02 .....	E11
EW10 N9 01 .....	E21	RA30 L1 00.....	A17, A18, A25, A26	RR02 N9 01 .....	E11
EW10 N9 02 .....	E21	RA30 L3 00.....	A17, A18	RR02 N9 02 .....	E11
EW11 00 01 .....	E21	RA31 63 00.....	A17, A18	RR04 N7 01 .....	E12
EX01 L1 00 .....	C4, E21	RA31 L1 00.....	A17, A18	RR04 N7 02 .....	E12
EX01 L3 00 .....	C4, E21	RA31 L3 00.....	A17, A18, A25, A26	RR04 N9 01 .....	E12
FL-ARROW-BLK-L*.....	A6	RA31 L8 00.....	A17, A18, A25, A26	RR04 N9 02 .....	E12
FL-ARROW-BLK-M*.....	A6	RA31 L8 K2 .....	A18	RR04 N9 N7 01 .....	E13
FL-ARROW-BLK-S* .....	A6	RA33 L1N24 .....	A18	RR04 N9 N7 02 .....	E13
FL-ARROW-WHT-L**.....	A6	RA33 L3N24 .....	A18	RR05 M4N06.....	E15
FL-ARROW-WHT-M**.....	A6	RA44 L1 00 46.....	A12	RR05 M4N10.....	E15
FL-ARROW-WHT-S**.....	A6	RA44 L3 00 46.....	A12	RR05 M4N12.....	E15
FP01 L1 01 .....	A7	RA44 L8 00 46.....	A12	RR05 M6N06.....	E15
FP01 L1 02 .....	A7	RA66 L8 L1.....	A14	RR05 M6N16.....	E15
FP01 L3 02 .....	A7	RA66 L8 L3.....	A14	RR05 M6N20.....	E15
FP01 L3 03 .....	A7	RA68 25N04 .....	A19, A21, B5	RR05 N7N06 01 .....	E15
RA02 L8 00.....	A10	RA68 40N04 .....	A19, A21, B5	RR05 N7N06 02 .....	E15
RA04 63 L1.....	A13	RA68 50N04 .....	A19, A21, B5	RR05 N9N08 01 .....	E15
RA04 L1 L3.....	A13	RA68 50N08 .....	A19, A21, B5	RR05 N9N08 02 .....	E15
RA04 L3 L8.....	A13	RA68 63N08 .....	A19, A21, B5	RR06 N7 01 .....	E11
RA04 L8 00.....	A12	RA69 25 17.....	A19, A21, B5	RR06 N7 02 .....	E11
RA04 L8 63.....	A12	RA69 40 25.....	A19, A21, B5	RR06 N9 01 .....	E11
RA04 L8 L1.....	A12	RA69 50 25.....	A19, A21, B5	RR06 N9 02 .....	E11
RA04 L8 L3.....	A12	RA69 63 25.....	A19, A21, B5	RR21 L1N20.....	A17, E15
RA07 40 00.....	A14	RP00 L1 00.....	A9	RR21 L1N24.....	A17, E15
RA07 50 00.....	A14	RP00 L3 00.....	A9	RR25 M4 00 .....	E14
RA07 63 00.....	A14	RP00 L8 00.....	A9	RR25 M6 00 .....	E14
RA07 L1 00.....	A14	RP02 M4 01.....	E12	RR25 N7 01 .....	E14
RA07 L1 03 46.....	A13	RP02 M4 02.....	E12	RR25 N7 02 .....	E14
RA07 L3 00.....	A14	RP02 M6 01.....	E12	RR25 N9 01 .....	E14
RA07 L3 03 46.....	A13	RP02 M6 02.....	E12	RR25 N9 02 .....	E14
RA07 L8 00.....	A14	RP04 M4 01.....	E13	RR63 L1N08.....	A19, A21, B5
RA07 L8 03 46.....	A13	RP04 M4 02.....	E13	RR63 L3N08.....	A19, A21, B5
RA12 L8 00.....	A11	RP04 M6 01.....	E13	RR63 L8N12.....	A20, A21, B5
RA25 L1 04.....	A15	RP04 M6 02.....	E13	RR63 L8N16.....	A20, A21, B5
RA25 L3 04.....	A15	RP06 M4 01.....	E11	RR65 M4N06.....	E14
RA25 L8 04.....	A15	RP06 M4 02.....	E11	RR65 M4N08.....	E14



RR65 M6N06.....	E14	TA16 L1 06 .....	A5
RR65 M6N08.....	E14	TA16 L3 02 .....	A5
RR89 L1N08 01 .....	E16, E20	TA16 L3 04 .....	A4
RR89 L1N08 02.....	E16, E20	TA16 L3 06 .....	A5
RR89 L3N08 01 .....	E16, E20	TA16 L8 02 .....	A5
RR89 L3N08 02.....	E16, E20	TA16 L8 04 .....	A4
RR89 M4N06 01 .....	E16, E20	TA16 L8 06 .....	A5
RR89 M4N06 02.....	E16, E20	TF16 N7 00.....	E10
RR89 M6N06 01 .....	E16, E20	TF16 N9 00.....	E10
RR89 M6N06 02.....	E16, E20	TRN-L.....	A6
RX02 L1 00.....	A10, E12	TRN-M.....	A6
RX02 L3 00.....	A10, E12	TRN-S.....	A6
RX04 L1 00.....	A12, E13	TX16 L1 00 .....	E10
RX04 L1 M4.....	E13	TX16 L3 00 .....	E10
RX04 L1 M6.....	E13	TX16 M4 00 .....	E10
RX04 L3 00.....	A12, E13	TX16 M6 00 .....	E10
RX04 L3 L1 .....	A12, E13	VAC-BLK-L*.....	A6
RX04 L3 M4.....	E13	VAC-BLK-M*.....	A6
RX04 L3 M6.....	E13	VAC-BLK-S* .....	A6
RX12 L1 00.....	A11	VP500P-4 .....	E19
RX12 L3 00.....	A11	VP500P-8 .....	E19
RX20 L1N04 .....	A13, E14	VP500P-12 .....	E19
RX20 L3N04 .....	A13, E14	VP500P-16 .....	E19
RX24 L1 40.....	A12	VP500P-24 .....	E19
RX24 L1 50.....	A12	VP500P-32 .....	E19
RX24 L1 63.....	A12	VP502SS-4.....	E19
RX24 L3 40.....	A12	VP502SS-8.....	E19
RX24 L3 50.....	A12	VP502SS-12.....	E19
RX24 L3 63.....	A12	VP502SS-16.....	E19
RX25 L1 00.....	A15, E15	VP502SS-24.....	E19
RX25 L3 00.....	A15, E15	VP502SS-32.....	E19
RX30 L1 00.....	A18, E16	VR01 L1 00.....	A25
RX30 L3 00.....	A18, E16	VR01 L3 00.....	A25
RX30 M4 00.....	E16, E18	VR01 L8 00.....	A25
RX30 M6 00.....	E16, E18	VR02 63 00.....	A26
RX31 L1 00.....	A18, E16, E18	VR02 L1 00US.....	A26
RX31 L3 00.....	A18, E16, E18	VR02 L1 01US.....	E18
RX64 L1 50.....	A14	VR02 L1 02US.....	E18
RX64 L1 63.....	A14	VR02 L3 00US.....	A26
RX64 L3 50.....	A14	VR02 L3 01US.....	E18
RX64 L3 63.....	A14	VR02 L3 02US.....	E18
RX66 L1 M6.....	E14	VR02 L8 00US.....	A26
RX66 L3 L1 .....	A14, E14	VR02 M4 01.....	E18
RX66 M6 M4.....	E14	VR02 M4 02.....	E18
TA16 L1 02 .....	A5	VR02 M6 01.....	E18
TA16 L1 04 .....	A4	VR02 M6 02.....	E18









## Parker Safety Guide for Selecting and Using Hose, Tubing, Fittings, Connectors, Conductors, Valves and Related Accessories

Parker Publication No. 4400-B.1

**WARNING:** Failure or improper selection or improper use of hose, tubing, fittings, assemblies, valves, connectors, conductors or related accessories ("Products") can cause death, personal injury and property damage. Possible consequences of failure or improper selection or improper use of these Products include but are not limited to:

- Fittings thrown off at high speed.
- High velocity fluid discharge.
- Explosion or burning of the conveyed fluid.
- Electrocutation from high voltage electric powerlines.
- Contact with suddenly moving or falling objects that are controlled by the conveyed fluid.
- Injections by high-pressure fluid discharge.
- Dangerously whipping Hose.
- Tube or pipe burst.
- Weld joint fracture.
- Contact with conveyed fluids that may be hot, cold, toxic or otherwise injurious.
- Sparking or explosion caused by static electricity buildup or other sources of electricity.
- Sparking or explosion while spraying paint or flammable liquids.
- Injuries resulting from inhalation, ingestion or exposure to fluids.

Before selecting or using any of these Products, it is important that you read and follow the instructions below. No product from any division in Fluid Connector Group is approved for in-flight aerospace applications. For hoses and fittings used in in-flight aerospace applications, please contact Parker Aerospace Group

### GENERAL INSTRUCTIONS

- 1.0 Scope:** This safety guide provides instructions for selecting and using (including assembling, installing, and maintaining) these Products. For convenience, all rubber and/or thermoplastic products commonly called "hose" or "tubing" are called "Hose" in this safety guide. Metallic tube or pipe are called "tube". All assemblies made with Hose are called "Hose Assemblies". All assemblies made with Tube are called "Tube Assemblies". All products commonly called "fittings", "couplings" or "adapters" are called "Fittings". Valves are fluid system components that control the passage of fluid. Related accessories are ancillary devices that enhance or monitor performance including crimping, flaring, flanging, presetting, bending, cutting, deburring, swaging machines, sensors, tags, lockout handles, spring guards and associated tooling. This safety guide is a supplement to and is to be used with the specific Parker publications for the specific Hose, Fittings and Related Accessories that are being considered for use. Parker publications are available at [www.parker.com](http://www.parker.com). SAE J1273 ([www.sae.org](http://www.sae.org)) and ISO 17165-2 ([www.ansi.org](http://www.ansi.org)) also provide recommended practices for hydraulic Hose Assemblies, and should be followed.
- 1.1 Fail-Safe:** Hose, Hose Assemblies, Tube, Tube Assemblies and Fittings can and do fail without warning for many reasons. Design all systems and equipment in a fail-safe mode, so that failure of the Hose, Hose Assembly, Tube, Tube Assembly or Fitting will not endanger persons or property.
- 1.2 Distribution:** Provide a copy of this safety guide to each person responsible for selecting or using Hose, Tube and Fitting products. Do not select or use Parker Hose, Tube or Fittings without thoroughly reading and understanding this safety guide as well as the specific Parker publications for the Products.
- 1.3 User Responsibility:** Due to the wide variety of operating conditions and applications for Hose, Tube and Fittings. Parker does not represent or warrant that any particular Hose, Tube or Fitting is suitable for any specific end use system. This safety guide does not analyze all technical parameters that must be considered in selecting a product. The user, through its own analysis and testing, is solely responsible for:
- Making the final selection of the Products.
  - Assuring that the user's requirements are met and that the application presents no health or safety hazards.
  - Following the safety guide for Related Accessories and being trained to operate Related Accessories.
  - Providing all appropriate health and safety warnings on the equipment on which the Products are used.
  - Assuring compliance with all applicable government and industry standards.
- 1.4 Additional Questions:** Call the appropriate Parker technical service department if you have any questions or require any additional information. See the Parker publication for the Products being considered or used, or call 1-800-CPARKER, or go to [www.parker.com](http://www.parker.com), for telephone numbers of the appropriate technical service department.

### 2.0 HOSE, TUBE AND FITTINGS SELECTION INSTRUCTIONS

- 2.1 Electrical Conductivity:** Certain applications require that the Hose be nonconductive to prevent electrical current flow. Other applications require the Hose and the Fittings and the Hose/Fitting interface to be sufficiently conductive to drain off static electricity. Extreme care must be exercised when selecting Hose, Tube and Fittings for these or any other applications in which electrical conductivity or nonconductivity is a factor.
- The electrical conductivity or nonconductivity of Hose, Tube and Fittings is dependent upon many factors and may be susceptible to change. These factors include but are not limited to the various materials used to make the Hose and the Fittings, Fitting finish (some Fitting finishes are electrically conductive while others are nonconductive), manufacturing methods (including moisture control), how the Fittings contact the Hose, age and amount of deterioration or damage or other changes, moisture content of the Hose at any particular time, and other factors.
- The following are considerations for electrically nonconductive and conductive Hose. For other applications consult the individual catalog pages and the appropriate industry or regulatory standards for proper selection.
- 2.1.1 Electrically Nonconductive Hose:** Certain applications require that the Hose be nonconductive to prevent electrical current flow or to maintain

electrical isolation. For applications that require Hose to be electrically nonconductive, including but not limited to applications near high voltage electric lines, only special nonconductive Hose can be used. The manufacturer of the equipment in which the nonconductive Hose is to be used must be consulted to be certain that the Hose, Tube and Fittings that are selected are proper for the application. Do not use any Parker Hose or Fittings for any such application requiring nonconductive Hose, including but not limited to applications near high voltage electric lines or dense magnetic fields, unless (i) the application is expressly approved in the Parker technical publication for the product, (ii) the Hose is marked "nonconductive", and (iii) the manufacturer of the equipment on which the Hose is to be used specifically approves the particular Parker Hose, Tube and Fittings for such use.

- 2.1.2 Electrically Conductive Hose:** Parker manufactures special Hose for certain applications that require electrically conductive Hose. Parker manufactures special Hose for conveying paint in airless paint spraying applications. This Hose is labeled "Electrically Conductive Airless Paint Spray Hose" on its layline and packaging. This Hose must be properly connected to the appropriate Parker Fittings and properly grounded in order to dissipate dangerous static charge buildup, which occurs in all airless paint spraying applications. Do not use any other Hose for airless paint spraying, even if electrically conductive. Use of any other Hose or failure to properly connect the Hose can cause a fire or an explosion resulting in death, personal injury, and property damage. All hoses that convey fuels must be grounded. Parker manufactures a special Hose for certain compressed natural gas ("CNG") applications where static electricity buildup may occur. Parker CNG Hose assemblies comply with the requirements of ANSI/IAS NGV 4.2; CSA 12.52, "Hoses for Natural Gas Vehicles and Dispensing Systems" ([www.ansi.org](http://www.ansi.org)). This Hose is labeled "Electrically Conductive for CNG Use" on its layline and packaging. This Hose must be properly connected to the appropriate Parker Fittings and properly grounded in order to dissipate dangerous static charge buildup, which occurs in, for example, high velocity CNG dispensing or transfer. Do not use any other Hose for CNG applications where static charge buildup may occur, even if electrically conductive. Use of other Hoses in CNG applications or failure to properly connect or ground this Hose can cause a fire or an explosion resulting in death, personal injury, and property damage. Care must also be taken to protect against CNG permeation through the Hose wall. See section 2.6, Permeation, for more information. Parker CNG Hose is intended for dispenser and vehicle use within the specified temperature range. Parker CNG Hose should not be used in confined spaces or unventilated areas or areas exceeding the specified temperature range. Final assemblies must be tested for leaks. CNG Hose Assemblies should be tested on a monthly basis for conductivity per ANSI/IAS NGV 4.2; CSA 12.52. Parker manufactures special Hose for aerospace in-flight applications. Aerospace in-flight applications employing Hose to transmit fuel, lubricating fluids and hydraulic fluids require a special Hose with a conductive inner tube. This Hose for in-flight applications is available only from Parker's Stratoflex Products Division. Do not use any other Parker Hose for in-flight applications, even if electrically conductive. Use of other Hoses for in-flight applications or failure to properly connect or ground this Hose can cause a fire or an explosion resulting in death, personal injury and property damage. These Hose assemblies for in-flight applications must meet all applicable aerospace industry, aircraft engine and aircraft requirements.
- 2.2 Pressure:** Hose, Tube and Fitting selection must be made so that the published maximum working pressure of the Hose, Tube and Fittings are equal to or greater than the maximum system pressure. The maximum working pressure of a Hose, or Tube Assembly is the lower of the respective published maximum working pressures of the Hose, Tube and the Fittings used. Surge pressures or peak transient pressures in the system must be below the published maximum working pressure for the Hose, Tube and Fitting. Surge pressures and peak pressures can usually only be determined by sensitive electrical instrumentation that measures and indicates pressures at millisecond intervals. Mechanical pressure gauges indicate only average pressures and cannot be used to determine surge pressures or peak transient pressures. Published burst pressure ratings for Hose is for manufacturing test purposes only and is no indication that the Product can be used in applications at the burst pressure or otherwise above the published maximum recommended working pressure.

- 2.3 Suction:** Hoses used for suction applications must be selected to insure that the Hose will withstand the vacuum and pressure of the system. Improperly selected Hose may collapse in suction application.
- 2.4 Temperature:** Be certain that fluid and ambient temperatures, both steady and transient, do not exceed the limitations of the Hose, Tube, Fitting and Seals. Temperatures below and above the recommended limit can degrade Hose, Tube, Fittings and Seals to a point where a failure may occur and release fluid. Tube and Fittings performances are normally degraded at elevated temperature. Material compatibility can also change at temperatures outside of the rated range. Properly insulate and protect the Hose Assembly when routing near hot objects (e.g. manifolds). Do not use any Hose in any application where failure of the Hose could result in the conveyed fluids (or vapors or mist from the conveyed fluids) contacting any open flame, molten metal, or other potential fire ignition source that could cause burning or explosion of the conveyed fluids or vapors.
- 2.5 Fluid Compatibility:** Hose, and Tube Assembly selection must assure compatibility of the Hose tube, cover, reinforcement, Tube, Plating and Seals with the fluid media used. See the fluid compatibility chart in the Parker publication for the product being considered or used. This information is offered only as a guide. Actual service life can only be determined by the end user by testing under all extreme conditions and other analysis. Hose, and Tube that is chemically compatible with a particular fluid must be assembled using Fittings and adapters containing likewise compatible seals. Flange or flare processes can change Tube material properties that may not be compatible with certain requirements such as NACE
- 2.6 Permeation:** Permeation (that is, seepage through the Hose or Seal) will occur from inside the Hose or Fitting to outside when Hose or Fitting is used with gases, liquid and gas fuels, and refrigerants (including but not limited to such materials as helium, diesel fuel, gasoline, natural gas, or LPG). This permeation may result in high concentrations of vapors which are potentially flammable, explosive, or toxic, and in loss of fluid. Dangerous explosions, fires, and other hazards can result when using the wrong Hose for such applications. The system designer must take into account the fact that this permeation will take place and must not use Hose or Fitting if this permeation could be hazardous. The system designer must take into account all legal, government, insurance, or any other special regulations which govern the use of fuels and refrigerants. Never use a Hose or Fitting even though the fluid compatibility is acceptable without considering the potential hazardous effects that can result from permeation through the Hose or Tube Assembly. Permeation of moisture from outside the Hose or Fitting to inside the Hose or Fitting will also occur in Hose or Tube assemblies, regardless of internal pressure. If this moisture permeation would have detrimental effects (particularly, but not limited to refrigeration and air conditioning systems), incorporation of sufficient drying capacity in the system or other appropriate system safeguards should be selected and used. The sudden pressure release of highly pressurized gas could also result in Explosive Decompression failure of permeated Seals and Hoses.
- 2.7 Size:** Transmission of power by means of pressurized fluid varies with pressure and rate of flow. The size of the components must be adequate to keep pressure losses to a minimum and avoid damage due to heat generation or excessive fluid velocity.
- 2.8 Routing:** Attention must be given to optimum routing to minimize inherent problems (kinking or flow restriction due to Hose collapse, twisting of the Hose, proximity to hot objects or heat sources). For additional routing recommendations see SAE J1273 and ISO 17165-2. Hose Assemblies have a finite life and should be installed in a manner that allows for ease of inspection and future replacement. Hose because of its relative short life, should not be used in residential and commercial buildings inside of inaccessible walls or floors, unless specifically allowed in the product literature. Always review all product literature for proper installation and routing instructions.
- 2.9 Environment:** Care must be taken to insure that the Hose, Tube and Fittings are either compatible with or protected from the environment (that is, surrounding conditions) to which they are exposed. Environmental conditions including but not limited to ultraviolet radiation, sunlight, heat, ozone, moisture, water, salt water, chemicals and air pollutants can cause degradation and premature failure.
- 2.10 Mechanical Loads:** External forces can significantly reduce Hose, Tube and Fitting life or cause failure. Mechanical loads which must be considered include excessive flexing, twist, kinking, tensile or side loads, bend radius, and vibration. Use of swivel type Fittings or adapters may be required to insure no twist is put into the Hose. Use of proper Hose or Tube clamps may also be required to reduce external mechanical loads. Unusual applications may require special testing prior to Hose selection.
- 2.11 Physical Damage:** Care must be taken to protect Hose from wear, snagging, kinking, bending smaller than minimum bend radius and cutting, any of which can cause premature Hose failure. Any Hose that has been kinked or bent to a radius smaller than the minimum bend radius, and any Hose that has been cut or is cracked or is otherwise damaged should be removed and discarded. Fittings with damages such as scratches on sealing surfaces and deformation should be replaced.
- 2.12 Proper End Fitting:** See instructions 3.2 through 3.5. These recommendations may be substantiated by testing to industry standards such as SAE J517 for hydraulic applications, or MIL-A-5070, AS1339, or AS3517 for Hoses from Parker's Stratoflex Products Division for aerospace applications.
- 2.13 Length:** When determining the proper Hose or Tube length of an assembly, be aware of Hose length change due to pressure, Tube length change due to thermal expansion or contraction, and Hose or Tube and machine tolerances and movement must be considered. When routing short hose assemblies, it is recommended that the minimum free hose length is always used. Consult the hose manufacturer for their minimum free hose length recommendations. Hose assemblies should be installed in such a way that any motion or flexing occurs within the same plane.
- 2.14 Specifications and Standards:** When selecting Hose, Tube and Fittings, government, industry, and Parker specifications and recommendations must be reviewed and followed as applicable.
- 2.15 Hose Cleanliness:** Hose and Tube components may vary in cleanliness levels. Care must be taken to insure that the Hose and Tube Assembly selected has an adequate level of cleanliness for the application.
- 2.16 Fire Resistant Fluids:** Some fire resistant fluids that are to be conveyed by Hose or Tube require use of the same type of Hose or Tube as used with petroleum base fluids. Some such fluids require a special Hose, Tube, Fitting and Seal, while a few fluids will not work with any Hose at all. See instructions 2.5 and 1.5. The wrong Hose, Tube, Fitting or Seal may fail after a very short service. In addition, all liquids but pure water may burn fiercely under certain conditions, and even pure water leakage may be hazardous.
- 2.17 Radiant Heat:** Hose and Seals can be heated to destruction without contact by such nearby items as hot manifolds or molten metal. The same heat source may then initiate a fire. This can occur despite the presence of cool air around the Hose or Seal. Performance of Tube and Fitting subjected to the heat could be degraded.
- 2.18 Welding or Brazing:** When using a torch or arc welder in close proximity to hydraulic lines, the hydraulic lines should be removed or shielded with appropriate fire resistant materials. Flame or weld spatter could burn through the Hose or Seal and possibly ignite escaping fluid resulting in a catastrophic failure. Heating of plated parts, including Hose Fittings and adapters, above 450°F (232°C) such as during welding, brazing or soldering may emit deadly gases. Any elastomer seal on fittings shall be removed prior to welding or brazing, any metallic surfaces shall be protected after brazing or welding when necessary. Welding and brazing filler material shall be compatible with the Tube and Fitting that are joined.
- 2.19 Atomic Radiation:** Atomic radiation affects all materials used in Hose and Tube assemblies. Since the long-term effects may be unknown, do not expose Hose or Tube assemblies to atomic radiation. Nuclear applications may require special Tube and Fittings.
- 2.20 Aerospace Applications:** The only Hose, Tube and Fittings that may be used for in-flight aerospace applications are those available from Parker's Stratoflex Products Division. Do not use any other Hose or Fittings for in-flight applications. Do not use any Hose or Fittings from Parker's Stratoflex Products Division with any other Hose or Fittings, unless expressly approved in writing by the engineering manager or chief engineer of Stratoflex Products Division and verified by the user's own testing and inspection to aerospace industry standards.
- 2.21 Unlocking Couplings:** Ball locking couplings or other Fittings with quick disconnect ability can unintentionally disconnect if they are dragged over obstructions, or if the sleeve or other disconnect member, is bumped or moved enough to cause disconnect. Threaded Fittings should be considered where there is a potential for accidental uncoupling.
- 3.0 HOSE AND FITTINGS ASSEMBLY AND INSTALLATION INSTRUCTIONS**
- 3.1 Component Inspection:** Prior to assembly, a careful examination of the Hose and Fittings must be performed. All components must be checked for correct style, size, catalog number, and length. The Hose must be examined for cleanliness, obstructions, blisters, cover looseness, kinks, cracks, cuts or any other visible defects. Inspect the Fitting and sealing surfaces for burrs, nicks, corrosion or other imperfections. Do NOT use any component that displays any signs of nonconformance.
- 3.2 Hose and Fitting Assembly:** Do not assemble a Parker Fitting on a Parker Hose that is not specifically listed by Parker for that Fitting, unless authorized in writing by the engineering manager or chief engineer of the appropriate Parker division. Do not assemble a Parker Fitting on another manufacturer's Hose or a Parker Hose on another manufacturer's Fitting unless (i) the engineering manager or chief engineer of the appropriate Parker division approves the Assembly in writing or that combination is expressly approved in the appropriate Parker literature for the specific Parker product, and (ii) the user verifies the Assembly and the application through analysis and testing. For Parker Hose that does not specify a Parker Fitting, the user is solely responsible for the selection of the proper Fitting and Hose Assembly procedures. See instruction 1.4. To prevent the possibility of problems such as leakage at the Fitting or system contamination, it is important to completely remove all debris from the cutting operation before installation of the Fittings. The Parker published instructions must be followed for assembling the Fittings on the Hose. These instructions are provided in the Parker Fitting catalog for the specific Parker Fitting being used, or by calling 1-800-CPARKER, or at [www.parker.com](http://www.parker.com).
- 3.3 Related Accessories:** Do not crimp or swage any Parker Hose or Fitting with anything but the listed swage or crimp machine and dies in accordance with Parker published instructions. Do not crimp or swage another manufacturer's Fitting with a Parker crimp or swage die unless authorized in writing by the engineering manager or chief engineer of the appropriate Parker division.
- 3.4 Parts:** Do not use any Parker Fitting part (including but not limited to socket, shell, nipple, or insert) except with the correct Parker mating parts, in accordance with Parker published instructions, unless authorized in writing by the engineering manager or chief engineer of the appropriate Parker division.
- 3.5 Field Attachable/Permanent:** Do not reuse any field attachable Hose Fitting that has blown or pulled off a Hose. Do not reuse a Parker permanent Hose Fitting (crimped or swaged) or any part thereof. Complete Hose Assemblies may only be reused after proper inspection under section 4.0. Do not assemble Fittings to any previously used hydraulic Hose that was in service, for use in a fluid power application.
- 3.6 Pre-Installation Inspection:** Prior to installation, a careful examination of the Hose Assembly must be performed. Inspect the Hose Assembly for any damage or defects. DO NOT use any Hose Assembly that displays any signs of nonconformance.
- 3.7 Minimum Bend Radius:** Installation of a Hose at less than the minimum listed bend radius may significantly reduce the Hose life. Particular attention must be given to preclude sharp bending at the Hose to Fitting juncture. Any bending during installation at less than the minimum bend radius must be avoided. If any Hose is kinked during installation, the Hose must be discarded.
- 3.8 Twist Angle and Orientation:** Hose Assembly installation must be such that relative motion of machine components does not produce twisting.
- 3.9 Securement:** In many applications, it may be necessary to restrain, protect, or guide the Hose to protect it from damage by unnecessary flexing, pressure surges, and contact with other mechanical components. Care must be taken to insure such restraints do not introduce additional stress or wear points.
- 3.10 Proper Connection of Ports:** Proper physical installation of the Hose Assembly

requires a correctly installed port connection insuring that no twist or torque is transferred to the Hose when the Fittings are being tightened or otherwise during use.

- 3.11 **External Damage:** Proper installation is not complete without insuring that tensile loads, side loads, kinking, flattening, potential abrasion, thread damage or damage to sealing surfaces are corrected or eliminated. See instruction 2.10.
- 3.12 **System Checkout:** All air entrapment must be eliminated and the system pressurized to the maximum system pressure (at or below the Hose maximum working pressure) and checked for proper function and freedom from leaks. Personnel must stay out of potential hazardous areas while testing and using.
- 3.13 **Routing:** The Hose Assembly should be routed in such a manner so if a failure does occur, the escaping media will not cause personal injury or property damage. In addition, if fluid media comes in contact with hot surfaces, open flame or sparks, a fire or explosion may occur. See section 2.4.
- 3.14 **Ground Fault Equipment Protection Devices (GFEPDs):** WARNING! Fire and Shock Hazard. To minimize the danger of fire if the heating cable of a Multitube bundle is damaged or improperly installed, use a Ground Fault Equipment Protection Device. Electrical fault currents may be insufficient to trip a conventional circuit breaker. For ground fault protection, the IEEE 515: ([www.ansi.org](http://www.ansi.org)) standard for heating cables recommends the use of GFEPDs with a nominal 30 milliampere trip level for "piping systems in classified areas, those areas requiring a high degree of maintenance, or which may be exposed to physical abuse or corrosive atmospheres".

#### 4.0 TUBE AND FITTINGS ASSEMBLY AND INSTALLATION INSTRUCTIONS

- 4.1 **Component Inspection:** Prior to assembly, a careful examination of the Tube and Fittings must be performed. All components must be checked for correct style, size, material, seal, and length. Inspect the Fitting and sealing surfaces for burrs, nicks, corrosion, missing seal or other imperfections. Do NOT use any component that displays any signs of nonconformance.
- 4.2 **Tube and Fitting Assembly:** Do not assemble a Parker Fitting with a Tube that is not specifically listed by Parker for that Fitting, unless authorized in writing by the engineering manager or chief engineer of the appropriate Parker division. The Tube must meet the requirements specified to the Fitting. The Parker published instructions must be followed for assembling the Fittings to a Tube. These instructions are provided in the Parker Fitting catalog for the specific Parker Fitting being used, or by calling 1-800-CPARKER, or at [www.parker.com](http://www.parker.com).
- 4.3 **Related Accessories:** Do not preset or flange Parker Fitting components using another manufacturer's equipment or procedures unless authorized in writing by the engineering manager or chief engineer of the appropriate Parker division. Tube, Fitting component and tooling must be checked for correct style, size and material. Operation and maintenance of Related Accessories must be in accordance with the operation manual for the designated Accessory.
- 4.4 **Securement:** In many applications, it may be necessary to restrain, protect, or guide the Tube to protect it from damage by unnecessary flexing, pressure surges, vibration, and contact with other mechanical components. Care must be taken to insure such restraints do not introduce additional stress or wear points.
- 4.5 **Proper Connection of Ports:** Proper physical installation of the Tube Assembly requires a correctly installed port connection insuring that no torque is transferred to the Tube when the Fittings are being tightened or otherwise during use.
- 4.6 **External Damage:** Proper installation is not complete without insuring that tensile loads, side loads, flattening, potential abrasion, thread damage or damage to sealing surfaces are corrected or eliminated. See instruction 2.10.
- 4.7 **System Checkout:** All air entrapment must be eliminated and the system pressurized to the maximum system pressure (at or below the Tube Assembly maximum working pressure) and checked for proper function and freedom from leaks. Personnel must stay out of potential hazardous areas while testing and using.
- 4.8 **Routing:** The Tube Assembly should be routed in such a manner so if a failure does occur, the escaping media will not cause personal injury or property damage. In addition, if fluid media comes in contact with hot surfaces, open flame or sparks, a fire or explosion may occur. See section 2.4.

#### 5.0 HOSE AND FITTING MAINTENANCE AND REPLACEMENT INSTRUCTIONS

- 5.1 Even with proper selection and installation, Hose life may be significantly reduced without a continuing maintenance program. The severity of the application, risk potential from a possible Hose failure, and experience with any Hose failures in the application or in similar applications should determine the frequency of the inspection and the replacement for the Products so that Products are replaced before any failure occurs. Certain products require maintenance and inspection per industry requirements. Failure to adhere to these requirements may lead to premature failure. A maintenance program must be established and followed by the user and, at minimum, must include instructions 5.2 through 5.7
- 5.2 **Visual Inspection Hose/Fitting:** Any of the following conditions require immediate shut down and replacement of the Hose Assembly:
  - Fitting slippage on Hose;
  - Damaged, cracked, cut or abraded cover (any reinforcement exposed);
  - Hard, stiff, heat cracked, or charred Hose;
  - Cracked, damaged, or badly corroded Fittings;
  - Leaks at Fitting or in Hose;
  - Kinked, crushed, flattened or twisted Hose; and
  - Blistered, soft, degraded, or loose cover.
- 5.3 **Visual Inspection All Other:** The following items must be tightened, repaired, corrected or replaced as required:
  - Leaking port conditions;
  - Excess dirt buildup;
  - Worn clamps, guards or shields; and
  - System fluid level, fluid type, and any air entrapment.
- 5.4 **Functional Test:** Operate the system at maximum operating pressure and check for possible malfunctions and leaks. Personnel must avoid potential hazardous areas while testing and using the system. See section 2.2.
- 5.5 **Replacement Intervals:** Hose assemblies and elastomeric seals used on Hose Fittings and adapters will eventually age, harden, wear and deteriorate under thermal cycling and compression set. Hose Assemblies and elastomeric seals

should be inspected and replaced at specific replacement intervals, based on previous service life, government or industry recommendations, or when failures could result in unacceptable downtime, damage, or injury risk. See section 1.2. Hose and Fittings may be subjected to internal mechanical and/or chemical wear from the conveying fluid and may fail without warning. The user must determine the product life under such circumstances by testing. Also see section 2.5.

- 5.6 **Hose Inspection and Failure:** Hydraulic power is accomplished by utilizing high pressure fluids to transfer energy and do work. Hoses, Fittings and Hose Assemblies all contribute to this by transmitting fluids at high pressures. Fluids under pressure can be dangerous and potentially lethal and, therefore, extreme caution must be exercised when working with fluids under pressure and handling the Hoses transporting the fluids. From time to time, Hose Assemblies will fail if they are not replaced at proper time intervals. Usually these failures are the result of some form of misapplication, abuse, wear or failure to perform proper maintenance. When Hoses fail, generally the high pressure fluids inside escape in a stream which may or may not be visible to the user. Under no circumstances should the user attempt to locate the leak by "feeling" with their hands or any other part of their body. High pressure fluids can and will penetrate the skin and cause severe tissue damage and possibly loss of limb. Even seemingly minor hydraulic fluid injection injuries must be treated immediately by a physician with knowledge of the tissue damaging properties of hydraulic fluid. If a Hose failure occurs, immediately shut down the equipment and leave the area until pressure has been completely released from the Hose Assembly. Simply shutting down the hydraulic pump may or may not eliminate the pressure in the Hose Assembly. Many times check valves, etc., are employed in a system and can cause pressure to remain in a Hose Assembly even when pumps or equipment are not operating. Tiny holes in the Hose, commonly known as pinholes, can eject small, dangerously powerful but hard to see streams of hydraulic fluid. It may take several minutes or even hours for the pressure to be relieved so that the Hose Assembly may be examined safely. Once the pressure has been reduced to zero, the Hose Assembly may be taken off the equipment and examined. It must always be replaced if a failure has occurred. Never attempt to patch or repair a Hose Assembly that has failed. Consult the nearest Parker distributor or the appropriate Parker division for Hose Assembly replacement information. Never touch or examine a failed Hose Assembly unless it is obvious that the Hose no longer contains fluid under pressure. The high pressure fluid is extremely dangerous and can cause serious and potentially fatal injury.
  - 5.7 **Elastomeric seals:** Elastomeric seals will eventually age, harden, wear and deteriorate under thermal cycling and compression set. Elastomeric seals should be inspected and replaced.
  - 5.8 **Refrigerant gases:** Special care should be taken when working with refrigeration systems. Sudden escape of refrigerant gases can cause blindness if the escaping gases contact the eye and can cause freezing or other severe injuries if it contacts any other portion of the body.
  - 5.9 **Compressed natural gas (CNG):** Parker CNG Hose Assemblies should be tested after installation and before use, and at least on a monthly basis per instructions provided on the Hose Assembly tag. The recommended procedure is to pressurize the Hose and check for leaks and to visually inspect the Hose for damage and to perform an electrical resistance test. Caution: Matches, candles, open flame or other sources of ignition shall not be used for Hose inspection. Leak check solutions should be rinsed off after use.
- #### 6.0 HOSE STORAGE
- 6.1 **Age Control:** Hose and Hose Assemblies must be stored in a manner that facilitates age control and first-in and first-out usage based on manufacturing date of the Hose and Hose Assemblies. Unless otherwise specified by the manufacturer or defined by local laws and regulations:
    - 6.1.1 The shelf life of rubber hose in bulk form or hose made from two or more materials is 28 quarters (7 years) from the date of manufacture, with an extension of 12 quarters (3 years), if stored in accordance with ISO 2230;
    - 6.1.2 The shelf life of thermoplastic and polytetrafluoroethylene hose is considered to be unlimited;
    - 6.1.3 Hose assemblies that pass visual inspection and proof test shall not be stored for longer than 2 years.
    - 6.1.4 **Storage:** Stored Hose and Hose Assemblies must not be subjected to damage that could reduce their expected service life and must be placed in a cool, dark and dry area with the ends capped. Stored Hose and Hose Assemblies must not be exposed to temperature extremes, ozone, oils, corrosive liquids or fumes, solvents, high humidity, rodents, insects, ultraviolet light, electromagnetic fields or radioactive materials.



## OFFER OF SALE

The items described in this document and other documents and descriptions provided by Parker Hannifin Corporation, its subsidiaries and its authorized distributors ("Seller") are hereby offered for sale at prices to be established by Seller. This offer and its acceptance by any customer ("Buyer") shall be governed by all of the following Terms and Conditions. Buyer's order for any item described in its document, when communicated to Seller verbally, or in writing, shall constitute acceptance of this offer. All goods or work described will be referred to as "Products".

1. **Terms and Conditions.** Seller's willingness to offer Products, or accept an order for Products, to or from Buyer is expressly conditioned on Buyer's assent to these Terms and Conditions and to the terms and conditions found on-line at [www.parker.com/saleterms/](http://www.parker.com/saleterms/). Seller objects to any contrary or additional term or condition of Buyer's order or any other document issued by Buyer.

2. **Price Adjustments; Payments.** Prices stated on the reverse side or preceding pages of this document are valid for 30 days. After 30 days, Seller may change prices to reflect any increase in its costs resulting from state, federal or local legislation, price increases from its suppliers, or any change in the rate, charge, or classification of any carrier. The prices stated on the reverse or preceding pages of this document do not include any sales, use, or other taxes unless so stated specifically. Unless otherwise specified by Seller, all prices are F.O.B. Seller's facility, and payment is due 30 days from the date of invoice. After 30 days, Buyer shall pay interest on any unpaid invoices at the rate of 1.5% per month or the maximum allowable rate under applicable law.

3. **Delivery Dates; Title and Risk; Shipment.** All delivery dates are approximate and Seller shall not be responsible for any damages resulting from any delay. Regardless of the manner of shipment, title to any products and risk of loss or damage shall pass to Buyer upon tender to the carrier at Seller's facility (i.e., when it's on the truck, it's yours). Unless otherwise stated, Seller may exercise its judgment in choosing the carrier and means of delivery. No deferment of shipment at Buyers' request beyond the respective dates indicated will be made except on terms that will indemnify, defend and hold Seller harmless against all loss and additional expense. Buyer shall be responsible for any additional shipping charges incurred by Seller due to Buyer's changes in shipping, product specifications or in accordance with Section 13, herein.

4. **Warranty.** Seller warrants that the Products sold hereunder shall be free from defects in material or workmanship for a period of ten years from the date of delivery to Buyer. This warranty is made only to Buyer and does not extend to anyone to whom Products are sold after purchased from Seller. The prices charged for Seller's products are based upon the exclusive limited warranty stated above, and upon the following disclaimer: **DISCLAIMER OF WARRANTY: THIS WARRANTY COMPRISES THE SOLE AND ENTIRE WARRANTY PERTAINING TO PRODUCTS PROVIDED HEREUNDER. SELLER DISCLAIMS ALL OTHER WARRANTIES, EXPRESS AND IMPLIED, INCLUDING MERCHANTABILITY AND FITNESS FOR A PARTICULAR PURPOSE.**

5. **Claims; Commencement of Actions.** Buyer shall promptly inspect all Products upon delivery. No claims for shortages will be allowed unless reported to the Seller within 10 days of delivery. No other claims against Seller will be allowed unless asserted in writing within 60 days after delivery or, in the case of an alleged breach of warranty, within 30 days after the date within the warranty period on which the defect is or should have been discovered by Buyer. Any action based upon breach of this agreement or upon any other claim arising out of this sale (other than an action by Seller for any amount due to Seller from Buyer) must be commenced within thirteen months from the date of tender of delivery by Seller or, for a cause of action based upon an alleged breach of warranty, within thirteen months from the date within the warranty period on which the defect is or should have been discovered by Buyer.

6. **LIMITATION OF LIABILITY.** UPON NOTIFICATION, SELLER WILL, AT ITS OPTION, REPAIR OR REPLACE A DEFECTIVE PRODUCT, OR REFUND THE PURCHASE PRICE. IN NO EVENT SHALL SELLER BE LIABLE TO BUYER FOR ANY SPECIAL, INDIRECT, INCIDENTAL OR CONSEQUENTIAL DAMAGES ARISING OUT OF, OR AS THE RESULT OF, THE SALE, DELIVERY, NON-DELIVERY, SERVICING, USE OR LOSS OF USE OF THE PRODUCTS OR ANY PART THEREOF, OR FOR ANY CHARGES OR EXPENSES OF ANY NATURE INCURRED WITHOUT SELLER'S WRITTEN CONSENT, EVEN IF SELLER HAS BEEN NEGLIGENT, WHETHER IN CONTRACT, TORT OR OTHER LEGAL THEORY. IN NO EVENT SHALL SELLER'S LIABILITY UNDER ANY CLAIM MADE BY BUYER EXCEED THE PURCHASE PRICE OF THE PRODUCTS.

7. **Contingencies.** Seller shall not be liable for any default or delay in performance if caused by circumstances beyond the reasonable control of Seller.

8. **User Responsibility.** The user, through its own analysis and testing, is solely responsible for making the final selection of the system and Product and assuring that all performance, endurance, maintenance, safety and warning requirements of the application are met. The user must analyze all aspects of the application and follow applicable industry standards and Product information. If Seller provides Product or system options, the user is responsible for determining that such data and specifications are suitable and sufficient for all applications and reasonably foreseeable uses of the Products or systems.

9. **Loss to Buyer's Property.** Any designs, tools, patterns, materials, drawings, confidential information or equipment furnished by Buyer or any other items which become Buyer's property, may be considered obsolete and may be destroyed by Seller after two consecutive years have elapsed without Buyer placing an order for the items which are manufactured using such property. Seller shall not be responsible for any loss or damage to such property while it is in Seller's possession or control.

10. **Special Tooling.** A tooling charge may be imposed for any special tooling, including without limitation, dies, fixtures, molds and patterns, acquired to manufacture Products. Such special tooling shall be and remain Seller's property notwithstanding payment of any charges by Buyer. In no event will Buyer acquire any interest in apparatus belonging to Seller which is utilized in the manufacture of the Products, even if such apparatus has been specially converted or adapted for such manufacture and notwithstanding any charges paid by Buyer. Unless otherwise agreed, Seller shall have the right to alter, discard or otherwise dispose of any special tooling or other property in its sole discretion at any time.

11. **Buyer's Obligation; Rights of Seller.** To secure payment of all sums due or otherwise, Seller shall retain a security interest in the goods delivered and this agreement shall be deemed a Security Agreement under the Uniform Commercial Code. Buyer authorizes Seller as its attorney to execute and file on Buyer's behalf all documents Seller deems necessary to perfect its security interest. Seller shall have a security interest in, and lien upon, any property of Buyer in Seller's possession as security for the payment of any amounts owed to Seller by Buyer.

12. **Improper use and Indemnity.** Buyer shall indemnify, defend, and hold Seller harmless from any claim, liability, damages, lawsuits, and costs (including attorney fees), whether for personal injury, property damage, patent, trademark or copyright infringement or any other claim, brought by or incurred by Buyer, Buyer's employees, or any other person, arising out of: (a) improper selection, improper application or other misuse of Products purchased by Buyer from Seller; (b) any act or omission, negligent or otherwise, of Buyer; (c) Seller's use of patterns, plans, drawings, or specifications furnished by Buyer to manufacture Product; or (d) Buyer's failure to comply with these terms and conditions. Seller shall not indemnify Buyer under any circumstance except as otherwise provided.

13. **Cancellations and Changes.** Orders shall not be subject to cancellation or change by Buyer for any reason, except with Seller's written consent and upon terms that will indemnify, defend and hold Seller harmless against all direct, incidental and consequential loss or damage. Seller may change product features, specifications, designs and availability with notice to Buyer.

14. **Limitation on Assignment.** Buyer may not assign its rights or obligations under this agreement without the prior written consent of Seller.

15. **Entire Agreement.** This agreement contains the entire agreement between the Buyer and Seller and constitutes the final, complete and exclusive expression of the terms of the agreement. All prior or contemporaneous written or oral agreements or negotiations with respect to the subject matter are herein merged.

16. **Waiver and Severability.** Failure to enforce any provision of this agreement will not waive that provision nor will any such failure prejudice Seller's right to enforce that provision in the future. Invalidation of any provision of this agreement by legislation or other rule of law shall not invalidate any other provision herein. The remaining provisions of this agreement will remain in full force and effect.

17. **Termination.** This agreement may be terminated by Seller for any reason and at any time by giving Buyer thirty (30) days written notice of termination. In addition, Seller may by written notice immediately terminate this agreement for the following: (a) Buyer commits a breach of any provision of this agreement (b) the appointment of a trustee, receiver or custodian for all or any part of Buyer's property (c) the filing of a petition for relief in bankruptcy of the other Party on its own behalf, or by a third party (d) an assignment for the benefit of creditors, or (e) the dissolution or liquidation of the Buyer.

18. **Governing Law.** This agreement and the sale and delivery of all Products hereunder shall be deemed to have taken place in and shall be governed and construed in accordance with the laws of the State of Ohio, as applicable to contracts executed and wholly performed therein and without regard to conflicts of laws principles. Buyer irrevocably agrees and consents to the exclusive jurisdiction and venue of the courts of Cuyahoga County, Ohio with respect to any dispute, controversy or claim arising out of or relating to this agreement. Disputes between the parties shall not be settled by arbitration unless, after a dispute has arisen, both parties expressly agree in writing to arbitrate the dispute.

19. **Indemnity for Infringement of Intellectual Property Rights.** Seller shall have no liability for infringement of any patents, trademarks, copyrights, trade dress, trade secrets or similar rights except as provided in this Section. Seller will defend and indemnify Buyer against allegations of infringement of U.S. patents, U.S. trademarks, copyrights, trade dress and trade secrets ("Intellectual Property Rights"). Seller will defend at its expense and will pay the cost of any settlement or damages awarded in an action brought against Buyer based on an allegation that a Product sold pursuant to this Agreement infringes the Intellectual Property Rights of a third party. Seller's obligation to defend and indemnify Buyer is contingent on Buyer notifying Seller within ten (10) days after Buyer becomes aware of such allegations of infringement, and Seller having sole control over the defense of any allegations or actions including all negotiations for settlement or compromise. If a Product is subject to a claim that it infringes the Intellectual Property Rights of a third party, Seller may, at its sole expense and option, procure for Buyer the right to continue using the Product, replace or modify the Product so as to make it noninfringing, or offer to accept return of the Product and return the purchase price less a reasonable allowance for depreciation. Notwithstanding the foregoing, Seller shall have no liability for claims of infringement based on information provided by Buyer, or directed to Products delivered hereunder for which the designs are specified in whole or part by Buyer, or infringements resulting from the modification, combination or use in a system of any Product sold hereunder. The foregoing provisions of this Section shall constitute Seller's sole and exclusive liability and Buyer's sole and exclusive remedy for infringement of Intellectual Property Rights.

20. **Taxes.** Unless otherwise indicated, all prices and charges are exclusive of excise, sales, use, property, occupational or like taxes which may be imposed by any taxing authority upon the manufacture, sale or delivery of Products.

21. **Equal Opportunity Clause.** For the performance of government contracts and where dollar value of the Products exceed \$10,000, the equal employment opportunity clauses in Executive Order 11246, VEVRAA, and 41 C.F.R. §§ 60-1.4(a), 60-741.5(a), and 60-250.4, are hereby incorporated.

# Parker's Motion & Control Product Groups

**At Parker, we're guided by a relentless drive to help our customers become more productive and achieve higher levels of profitability by engineering the best systems for their requirements. It means looking at customer applications from many angles to find new ways to create value. Whatever the motion and control technology need, Parker has the experience, breadth of product and global reach to consistently deliver. No company knows more about motion and control technology than Parker. For further info call 1 800 G-Parker (1 800 272 7537).**



## Aerospace

### Key Markets

Aftermarket services  
Commercial transports  
Engines  
General & business aviation  
Helicopters  
Launch vehicles  
Military aircraft  
Missiles  
Power generation  
Regional transports  
Unmanned aerial vehicles

### Key Products

Control systems & actuation products  
Engine systems & components  
Fluid conveyance systems & components  
Fluid metering, delivery & atomization devices  
Fuel systems & components  
Fuel tank inerting systems  
Hydraulic systems & components  
Thermal management  
Wheels & brakes



## Automation

### Key Markets

Alternative energy  
Conveyor & material handling  
Factory automation  
Food & beverage  
Life sciences & medical  
Machine tools  
Packaging machinery  
Paper machinery  
Plastics machinery  
Primary metals  
Safety & security  
Semiconductor & electronics  
Transportation & automotive

### Key Products

AC/DC drives & systems  
Air preparation  
Electric actuators, gantry robots & slides  
Human machine interfaces  
Inverters  
Manifolds  
Miniature fluidics  
Pneumatic actuators & grippers  
Pneumatic valves & controls  
Rotary actuators  
Stepper motors, servo motors, drives & controls  
Structural extrusions  
Vacuum generators, cups & sensors



## Climate & Industrial Controls

### Key Markets

Agriculture  
Air conditioning  
Construction Machinery  
Food & beverage  
Industrial machinery  
Life sciences  
Oil & gas  
Precision cooling  
Process  
Refrigeration  
Transportation

### Key Products

Accumulators  
Advanced actuators  
CO<sub>2</sub> controls  
Electronic controllers  
Filter driers  
Hand shut-off valves  
Heat exchangers  
Hose & fittings  
Pressure regulating valves  
Refrigerant distributors  
Safety relief valves  
Smart pumps  
Solenoid valves  
Thermostatic expansion valves



## Filtration

### Key Markets

Aerospace  
Food & beverage  
Industrial plant & equipment  
Life sciences  
Marine  
Mobile equipment  
Oil & gas  
Power generation & renewable energy  
Process  
Transportation  
Water Purification

### Key Products

Analytical gas generators  
Compressed air filters & dryers  
Engine air, coolant, fuel & oil filtration systems  
Fluid condition monitoring systems  
Hydraulic & lubrication filters  
Hydrogen, nitrogen & zero air generators  
Instrumentation filters  
Membrane & fiber filters  
Microfiltration  
Sterile air filtration  
Water desalination & purification filters & systems



## Fluid Connectors

### Key Markets

Aerial lift  
Agriculture  
Bulk chemical handling  
Construction machinery  
Food & beverage  
Fuel & gas delivery  
Industrial machinery  
Life sciences  
Marine  
Mining  
Mobile  
Oil & gas  
Renewable energy  
Transportation

### Key Products

Check valves  
Connectors for low pressure fluid conveyance  
Deep sea umbilicals  
Diagnostic equipment  
Hose couplings  
Industrial hose  
Mooring systems & power cables  
PTFE hose & tubing  
Quick couplings  
Rubber & thermoplastic hose  
Tube fittings & adapters  
Tubing & plastic fittings



## Hydraulics

### Key Markets

Aerial lift  
Agriculture  
Alternative energy  
Construction machinery  
Forestry  
Industrial machinery  
Machine tools  
Marine  
Material handling  
Mining  
Oil & gas  
Power generation  
Refuse vehicles  
Renewable energy  
Truck hydraulics  
Turf equipment

### Key Products

Accumulators  
Cartridge valves  
Electrohydraulic actuators  
Human machine interfaces  
Hybrid drives  
Hydraulic cylinders  
Hydraulic motors & pumps  
Hydraulic systems  
Hydraulic valves & controls  
Hydrostatic steering  
Integrated hydraulic circuits  
Power take-offs  
Power units  
Rotary actuators  
Sensors



## Instrumentation

### Key Markets

Alternative fuels  
Biopharmaceuticals  
Chemical & refining  
Food & beverage  
Marine & shipbuilding  
Medical & dental  
Microelectronics  
Nuclear Power  
Offshore oil exploration  
Oil & gas  
Pharmaceuticals  
Power generation  
Pulp & paper  
Steel  
Water/wastewater

### Key Products

Analytical Instruments  
Analytical sample conditioning products & systems  
Chemical injection fittings & valves  
Fluoropolymer chemical delivery fittings, valves & pumps  
High purity gas delivery fittings, valves, regulators & digital flow controllers  
Industrial mass flow meters/controllers  
Permanent no-weld tube fittings  
Precision industrial regulators & flow controllers  
Process control double block & bleeds  
Process control fittings, valves, regulators & manifold valves



## Seal

### Key Markets

Aerospace  
Chemical processing  
Consumer  
Fluid power  
General industrial  
Information technology  
Life sciences  
Microelectronics  
Military  
Oil & gas  
Power generation  
Renewable energy  
Telecommunications  
Transportation

### Key Products

Dynamic seals  
Elastomeric o-rings  
Electro-medical instrument design & assembly  
EMI shielding  
Extruded & precision-cut, fabricated elastomeric seals  
High temperature metal seals  
Homogeneous & inserted elastomeric shapes  
Medical device fabrication & assembly  
Metal & plastic retained composite seals  
Shielded optical windows  
Silicone tubing & extrusions  
Thermal management  
Vibration dampening



ENGINEERING YOUR SUCCESS.

# Parker Fluid Connectors Group

## North American Divisions & Distribution Service Centers

**Your complete source** for quality tube fittings, hose & hose fittings, brass & composite fittings, quick-disconnect couplings, valves and assembly tools, locally available from a worldwide network of authorized distributors.

### **Fittings:**

Available in inch and metric sizes covering SAE, BSP, DIN, GAZ, JIS and ISO thread configurations, manufactured from steel, stainless steel, brass, aluminum, nylon and thermoplastic.

### **Hose, Tubing and Bundles:**

Available in a wide variety of sizes and materials including rubber, wire-reinforced, thermoplastic, hybrid and custom compounds.

### **Worldwide Availability:**

Parker operates Fluid Connectors manufacturing locations and sales offices throughout North America, South America, Europe and Asia-Pacific.

**For information**, call toll free...

**1-800-C-PARKER**  
**(1-800-272-7537)**

### **North American Divisions**

#### **Fluid System Connectors Division**

Otsego, MI  
phone 269 692 6555  
fax 269 694 4614

**Engineering Support:**  
fscapps@parker.com

**Customer Support:**  
fscsales@parker.com

**Quote Support:**  
fscquote@parker.com

#### **Hose Products Division**

Wickliffe, OH  
phone 440 943 5700  
fax 440 943 3129

#### **Parflex Division**

Ravenna, OH  
phone 330 296 2871  
fax 330 296 8433

#### **Quick Coupling Division**

Minneapolis, MN  
phone 763 544 7781  
fax 763 544 3418

#### **Tube Fittings Division**

Columbus, OH  
phone 614 279 7070  
fax 614 279 7685

### **Distribution Service Centers**

#### **Buena Park, CA**

phone 714 522 8840  
fax 714 994 1183

#### **Conyers, GA**

phone 770 929 0330  
fax 770 929 0230

#### **Louisville, KY**

phone 502 937 1322  
fax 502 937 4180

#### **Portland, OR**

phone 503 283 1020  
fax 503 283 2201

#### **Toledo, OH**

phone 419 878 7000  
fax 419 878 7001  
fax 419 878 7420  
(FCG Kit Operations)

#### **Canada**

##### **Milton, ONT**

phone 905 693 3000  
fax 905 876 1958

#### **Mexico**

##### **Toluca, MEX**

phone (52) 722 2754 200  
fax (52) 722 2722 168

